

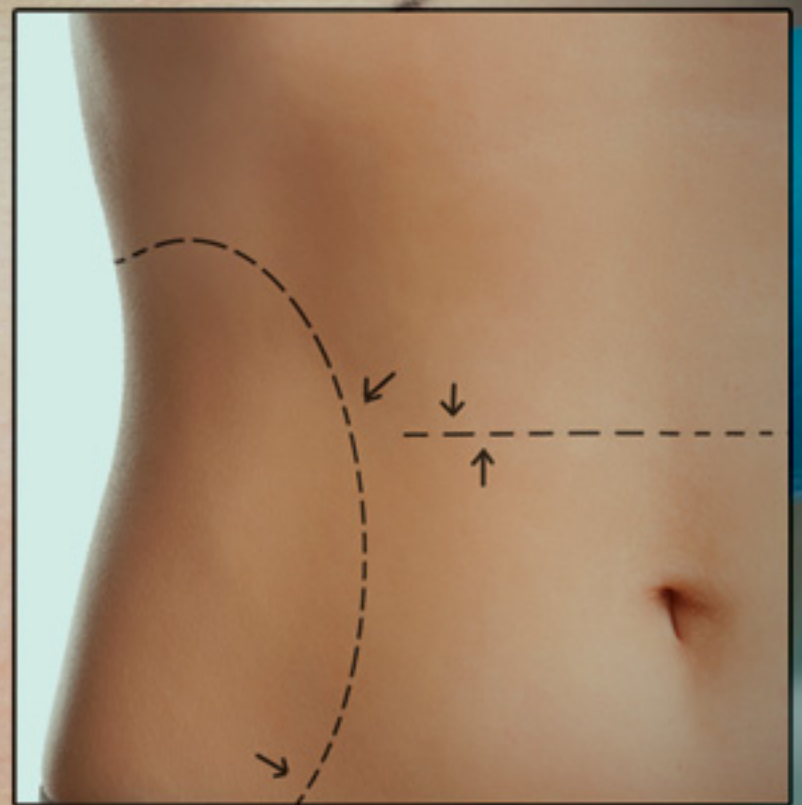

**GLORIOUS**  
danmark



**GLORIOUS ENTERPRISES**

Edition II





Delicate Scissors	02
Dissecting Scissors	03 - 05
Abdominal Scissors	06
Operating Scissors	07
Dissecting Scissors	08 - 10
Artery Forceps, Towel Clamps	11
Face Lift Forceps	12
Needle Holders	13 - 15
Micro Scissors	16 - 19
Micro Needle Holders	20 - 22
Dressing Forceps, Tissue Forceps	23 - 24
Hooks & Retractors	25 - 30
Breast Retractors	36 - 36
Breast Markers	37
Nasal Instruments	38 - 45
Skin Graft Knives	46
Liposuction Instruments	47 - 52

**M.A.Arain & Brother (Pvt) Ltd.** Manufacture **SuperCut Scissors** highest quality stainless steel. These scissors have a specially designed razor-sharp upper blade edge that cuts effortlessly through tissue. The lower blade has micro-fine serrations to hold and prevent tissue slippage

### Identification



**Tungsten Carbide Scissor**



**Supercut Scissor**

One Blade Razor Sharp Edge  
One Blade Micro-fine Serration



**Supercut Plus T/c Scissor**

Tungsten Carbide Blades  
One Blade Micro-fine Serration



IRIS

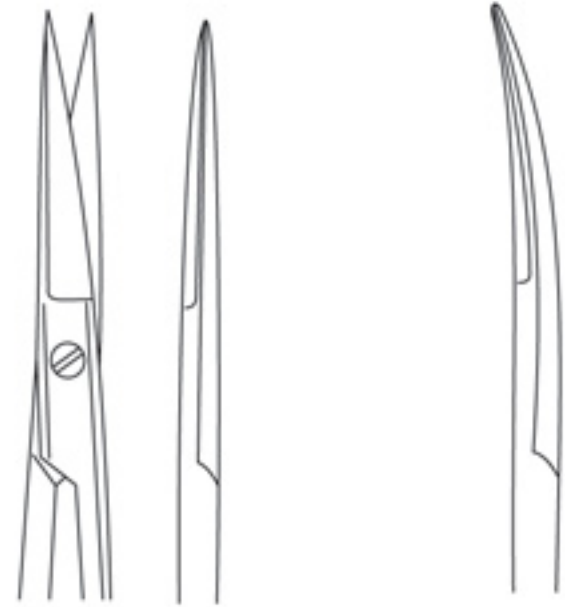

Straight

Curved

Straight	TC	SUPERCUT	SUPERCUT PLUS TC
11.5 cm/4½"	42.1208.11	42.1342.11	42.1501.11

Curved	TC	SUPERCUT	SUPERCUT PLUS TC
11.5 cm/4½"	42.1213.11	42.1345.11	42.1502.11



IRIS  
RIBBON HANDLE

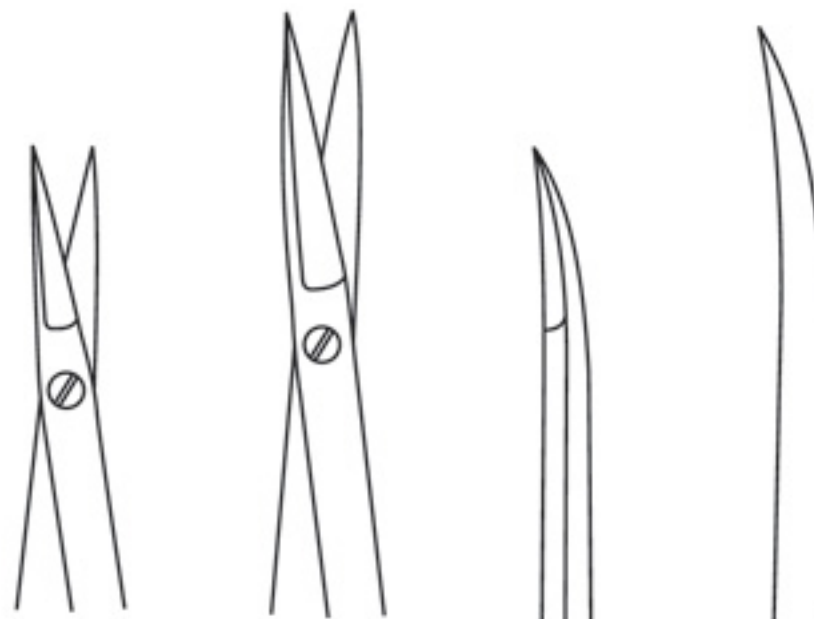

Straight

Curved

Straight	TC	SUPERCUT	SUPERCUT PLUS TC
9.5 cm/ 3¾"	42.1215.09	42.1362.09	42.1505.09
10.5 cm/ 4¼"	42.1217.10	42.1364.10	42.1506.10

Curved	TC	SUPERCUT	SUPERCUT PLUS TC
9.5 cm/ 3¾"	42.1220.09	42.1366.09	42.1508.09
10.5 cm/ 4¼"	42.1222.10	42.1367.10	42.1509.10



STEVENS



Straight	TC	SUPERCUT	SUPERCUT PLUS TC
11.5 cm/4½"	42.1225.11	42.1369.11	42.1512.11
13 cm/5½"	42.1226.13	42.1370.13	42.1513.13

Curved	TC	SUPERCUT	SUPERCUT PLUS TC
11.5 cm/4½"	42.1229.11	42.1374.11	42.1517.11
13 cm/5½"	42.1230.13	42.1375.13	42.1518.11



MINI-METZENBAUM



Straight	TC	SUPERCUT	SUPERCUT PLUS TC
9 cm/3½"	42.1232.09	42.1378.09	42.1521.09

Curved	TC	SUPERCUT	SUPERCUT PLUS TC
9 cm/3½"	42.1234.09	42.1380.09	42.1525.09



BABY-METZENBAUM

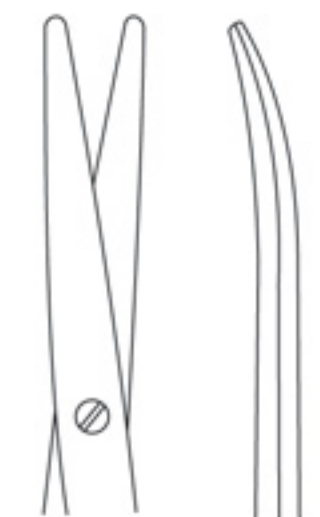

Straight	TC	SUPERCUT	SUPERCUT PLUS TC
11.5 cm/4½"	42.1236.11	42.1385.11	42.1528.11

Curved	TC	SUPERCUT	SUPERCUT PLUS TC
11.5 cm/4½"	42.1238.11	42.1387.11	42.1529.11





METZENBAUM

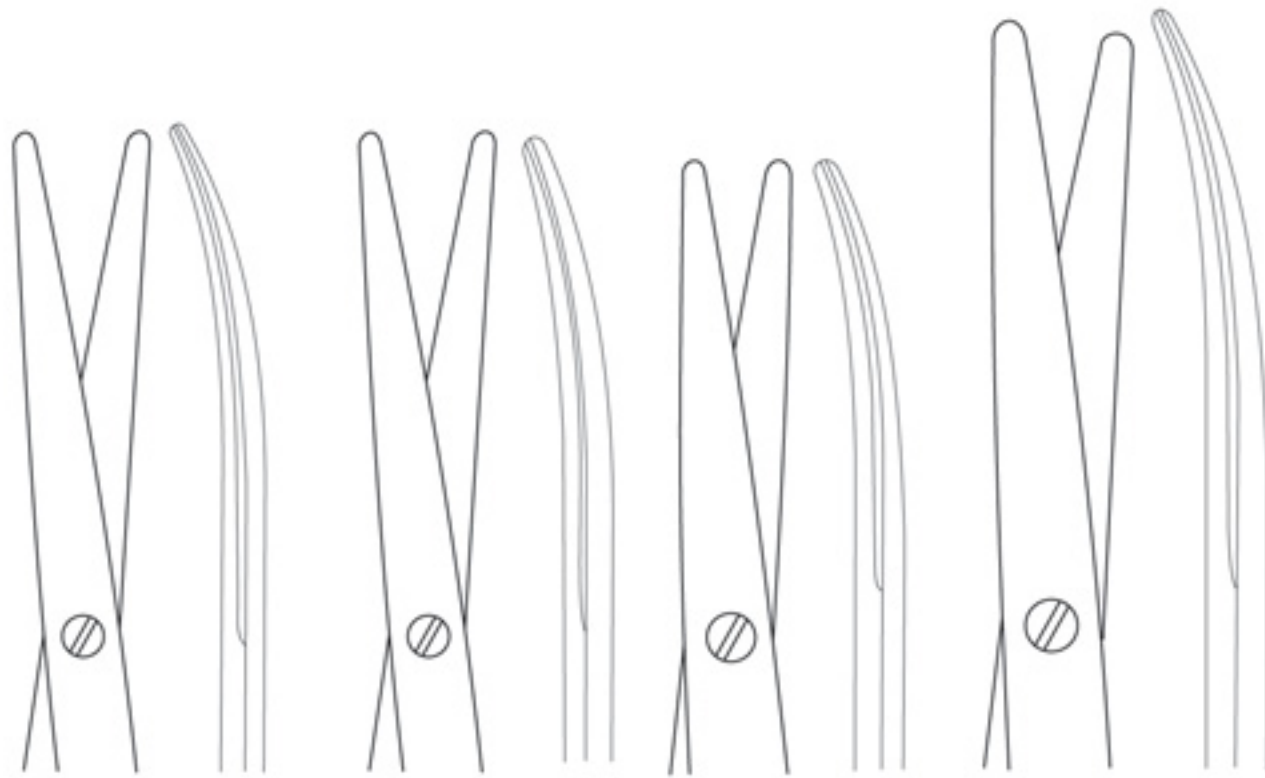

Straight	TC	SUPERCUT	SUPERCUT PLUS TC
14 cm/5½"	42.1045.14	42.1291.14	42.1532.14
15 cm/6"	42.1046.15	42.1294.15	42.1534.15
18 cm/7"	42.1048.18	42.1298.18	42.1536.18
20 cm/8"	42.1052.20	42.1202.20	42.1538.20

Curved	TC	SUPERCUT	SUPERCUT PLUS TC
14 cm/5½"	42.1070.14	42.1312.14	42.1542.14
15 cm/6"	42.1073.15	42.1313.15	42.1545.15
18 cm/7"	42.1071.18	42.1317.18	42.1548.18
20 cm/8"	42.1075.20	42.1321.20	42.1551.20



METZENBAUM-SLIM

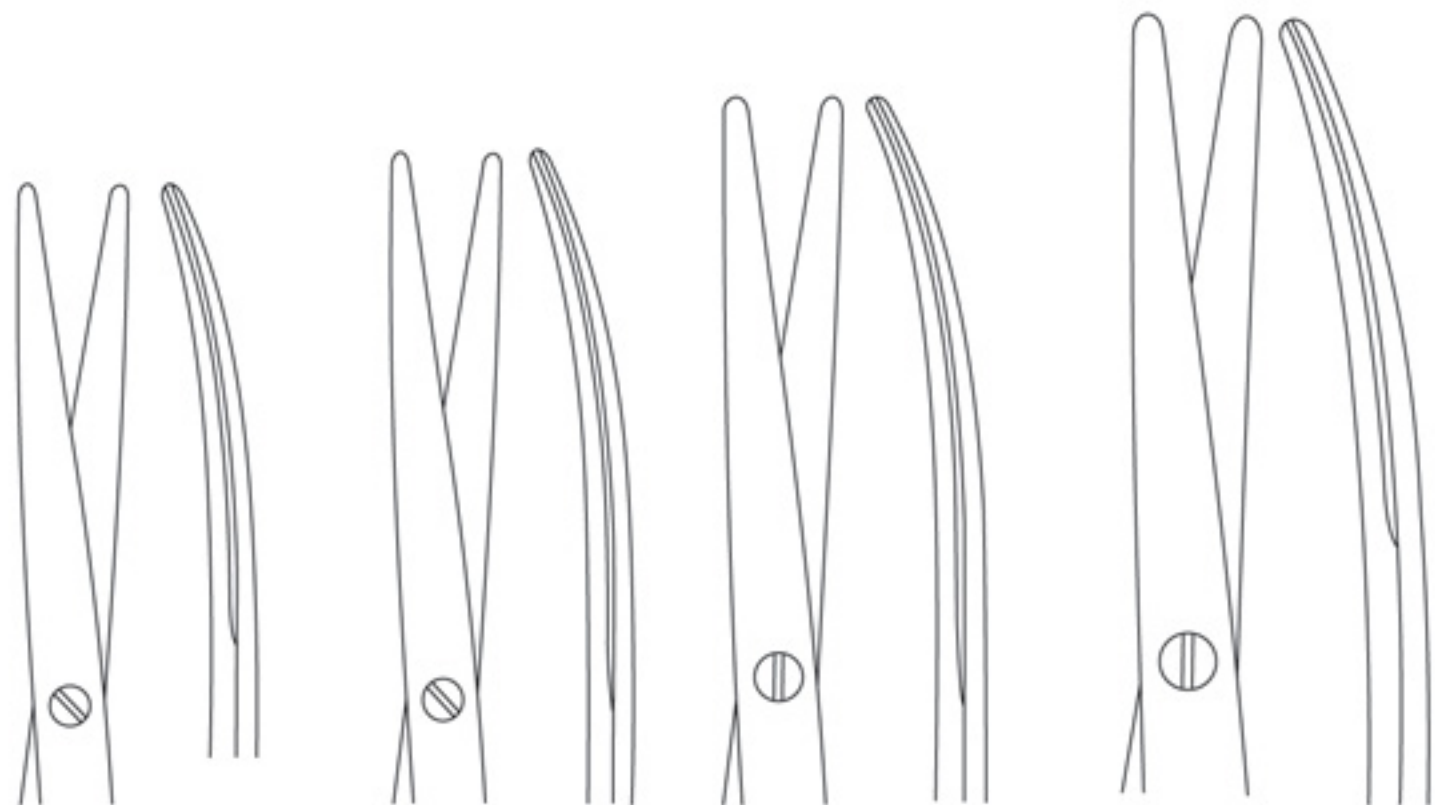

Straight	TC	SUPERCUT	SUPERCUT PLUS TC
14 cm/5½"	42.1240.14	42.1385.14	42.1555.14
15 cm/6"	42.1241.15	42.1387.15	42.1558.15
18 cm/7"	42.1242.18	42.1390.18	42.1559.18
20 cm/8"	42.1243.20	42.1392.20	42.1562.20

Curved	TC	SUPERCUT	SUPERCUT PLUS TC
14 cm/5½"	42.1247.14	42.1395.14	42.1565.14
15 cm/6"	42.1248.15	42.1397.15	42.1567.15
18 cm/7"	42.1249.18	42.1399.18	42.1569.18
20 cm/8"	42.1250.20	42.1403.20	42.1572.20



MAYO

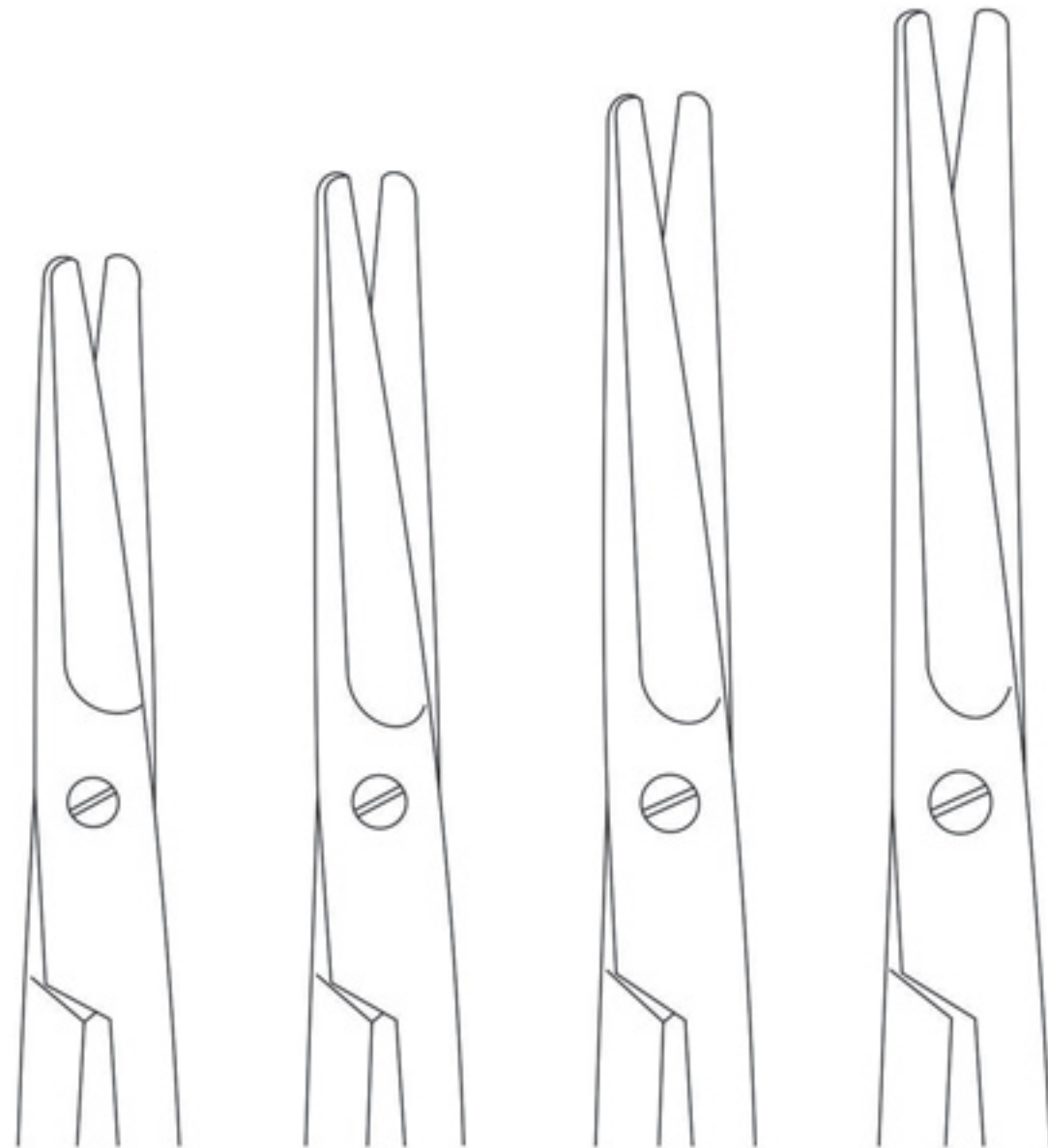

Straight	TC	SUPERCUT	SUPERCUT PLUS TC
14 cm/5½"	42.1016.14	42.1245.14	42.1575.14
15.5 cm/6⅝"	42.1017.15	42.1246.15	42.1578.15
17 cm/6¾"	42.1020.17	42.1247.17	42.1581.17
23 cm/9"	42.1021.23	42.1248.23	42.1583.23

Curved	TC	SUPERCUT	SUPERCUT PLUS TC
14 cm/5½"	42.1023.14	42.1250.14	42.1588.14
15.5 cm/6⅝"	42.1024.15	42.1251.15	42.1591.15
17 cm/6¾"	42.1027.17	42.1252.17	42.1594.17
23 cm/9"	42.1029.23	42.1253.23	42.1597.18



MAYO-STILLE

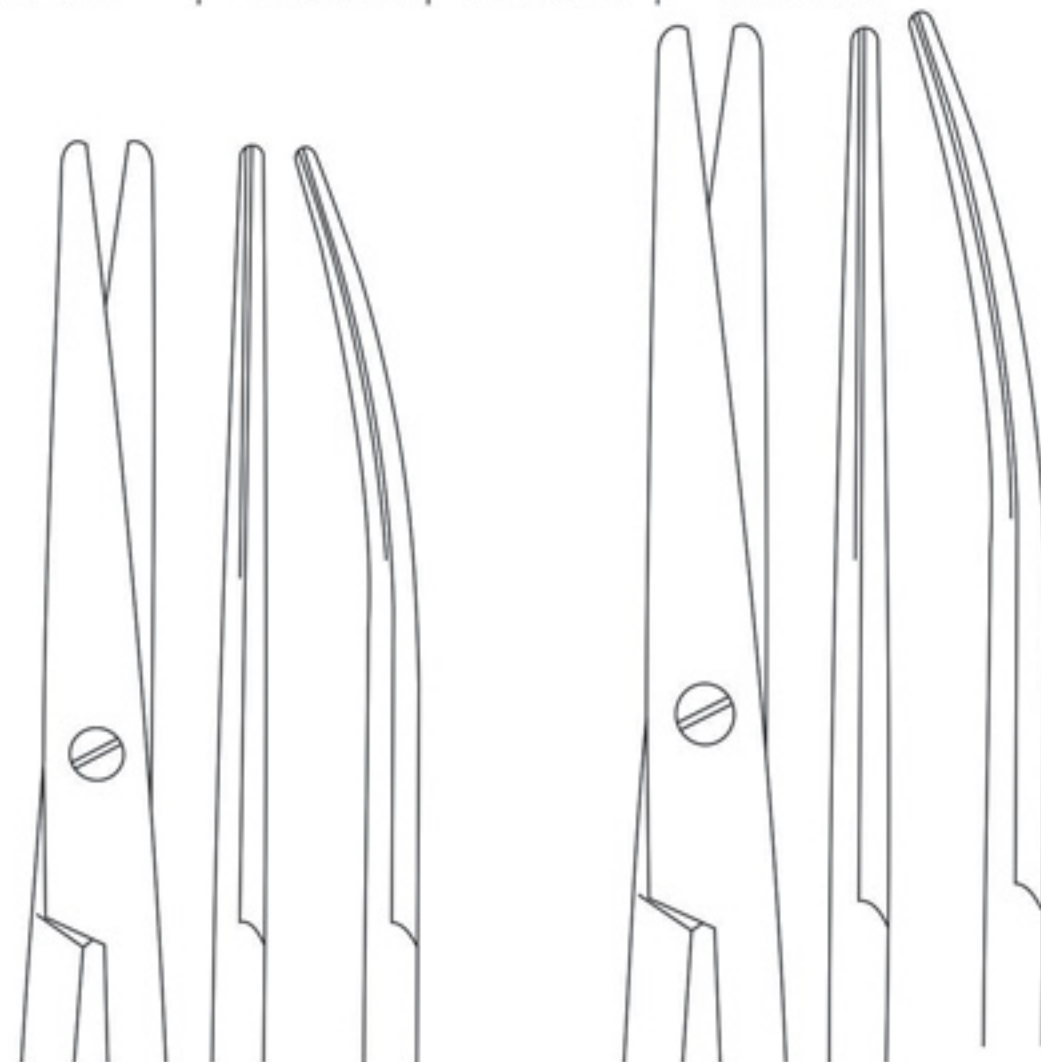

Straight	TC	SUPERCUT	SUPERCUT PLUS TC
15 cm/6"	42.1270.15	42.1251.15	42.1601.15
17 cm/6¾"	42.1272.17	42.1258.17	42.1603.17

Curved	TC	SUPERCUT	SUPERCUT PLUS TC
15 cm/6"	42.1275.15	42.1261.15	42.1605.15
17 cm/6¾"	42.1278.17	42.1265.17	42.1607.17





DOYEN



Straight	TC	SUPERCUT	SUPERCUT PLUS TC
18 cm	42.1280.18	42.1407.18	42.1601.18

Curved	TC	SUPERCUT	SUPERCUT PLUS TC
18 cm	42.1285.18	42.1409.18	42.1604.18



SIMS



Straight	TC	SUPERCUT	SUPERCUT PLUS TC
20 cm	42.1287.20	42.1412.20	42.1608.20
23 cm	42.1289.23	42.1415.23	42.1611.23

Curved	TC	SUPERCUT	SUPERCUT PLUS TC
20 cm	42.1039.20	42.1417.20	42.1615.20
23 cm	42.1043.23	42.1419.23	42.1619.23



SIEBOLD

	TC	SUPERCUT	SUPERCUT PLUS TC
24.5 cm/9¾"	42.1290.24	42.1423.24	42.1623.24



	TC	SUPERCUT	SUPERCUT PLUS TC
25 cm/10"	42.1294.25	42.1426.25	42.1627.25



RESANO





RAGNELL (KILNER)



	TC	SUPERCUT	SUPERCUT PLUS TC
13 cm/5½"	42.1802.13	42.1429.13	42.1630.13
15 cm/6"	42.1805.15	42.1281.15	42.1633.15
18 cm/7½"	42.1808.18	42.1285.18	42.1635.18



PECK-JOSEPH



Straight	TC	SUPERCUT	SUPERCUT PLUS TC
14 cm/5½"	42.1810.14	42.1431.14	42.1637.14

Curved	TC	SUPERCUT	SUPERCUT PLUS TC
14 cm/5½"	42.1813.14	42.1435.14	42.1639.14



METZENBAUM-FREEMAN

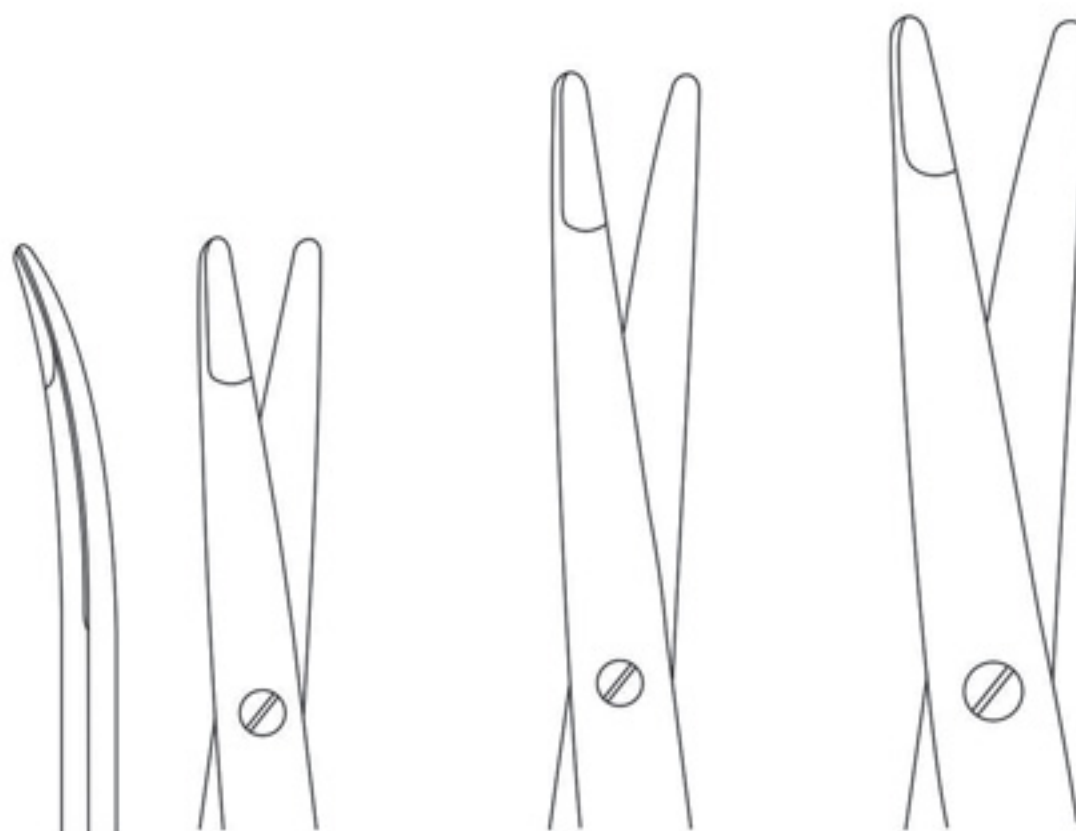

	TC	SUPERCUT	SUPERCUT PLUS TC
18 cm/7 $\frac{1}{8}$ "	42.1819.18	42.1437.18	42.1643.18
20 cm/8"	42.1821.20	42.1440.20	42.1647.20
23 cm/9"	42.1823.23	42.1443.23	42.1650.23

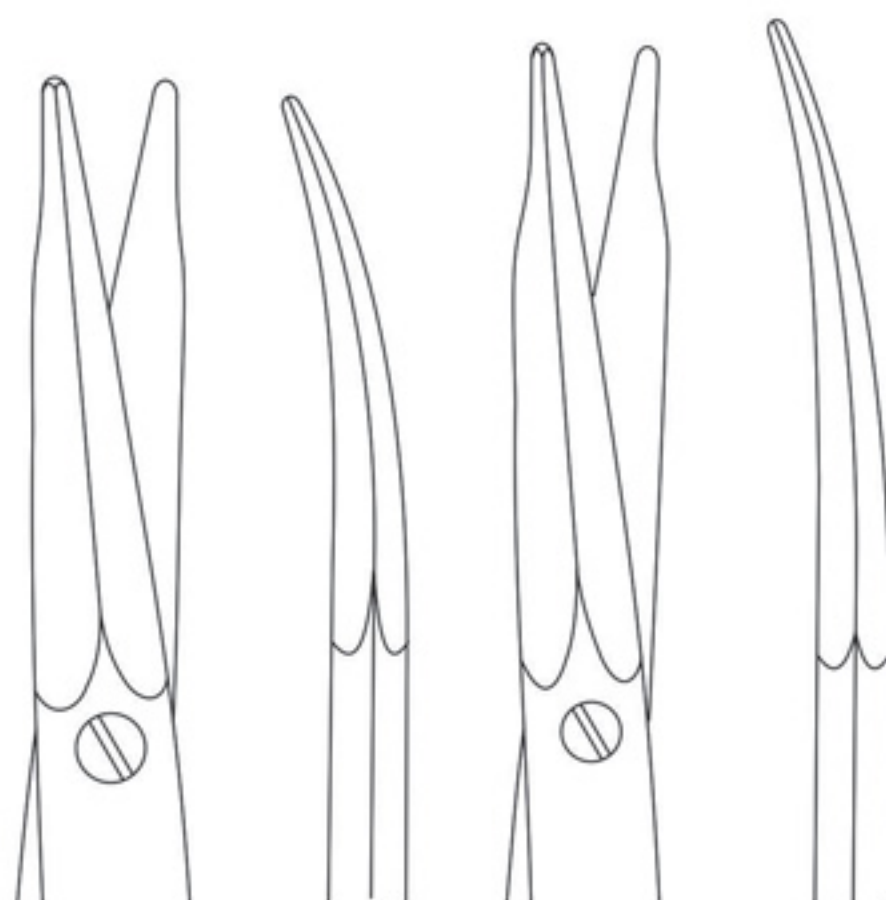

Straight	TC	SUPERCUT	SUPERCUT PLUS TC
16.5 cm/6 $\frac{1}{2}$ "	42.1825.16	42.1447.16	42.1655.16
20.5 cm/8"	42.1827.20	42.1451.20	42.1657.20

Curved	TC	SUPERCUT	SUPERCUT PLUS TC
16.5 cm/6 $\frac{1}{2}$ "	42.1830.16	42.1455.16	42.1660.16
20.5 cm/8"	42.1833.20	42.1457.20	42.1663.20



FANOUS





GORNEY  
FACELIFT

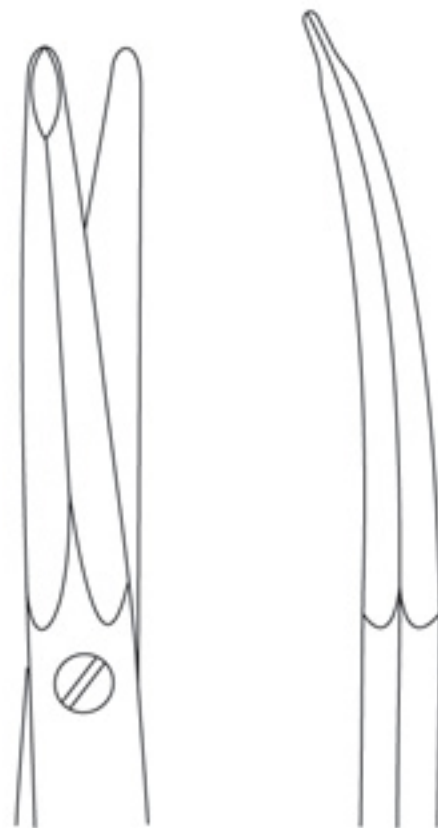
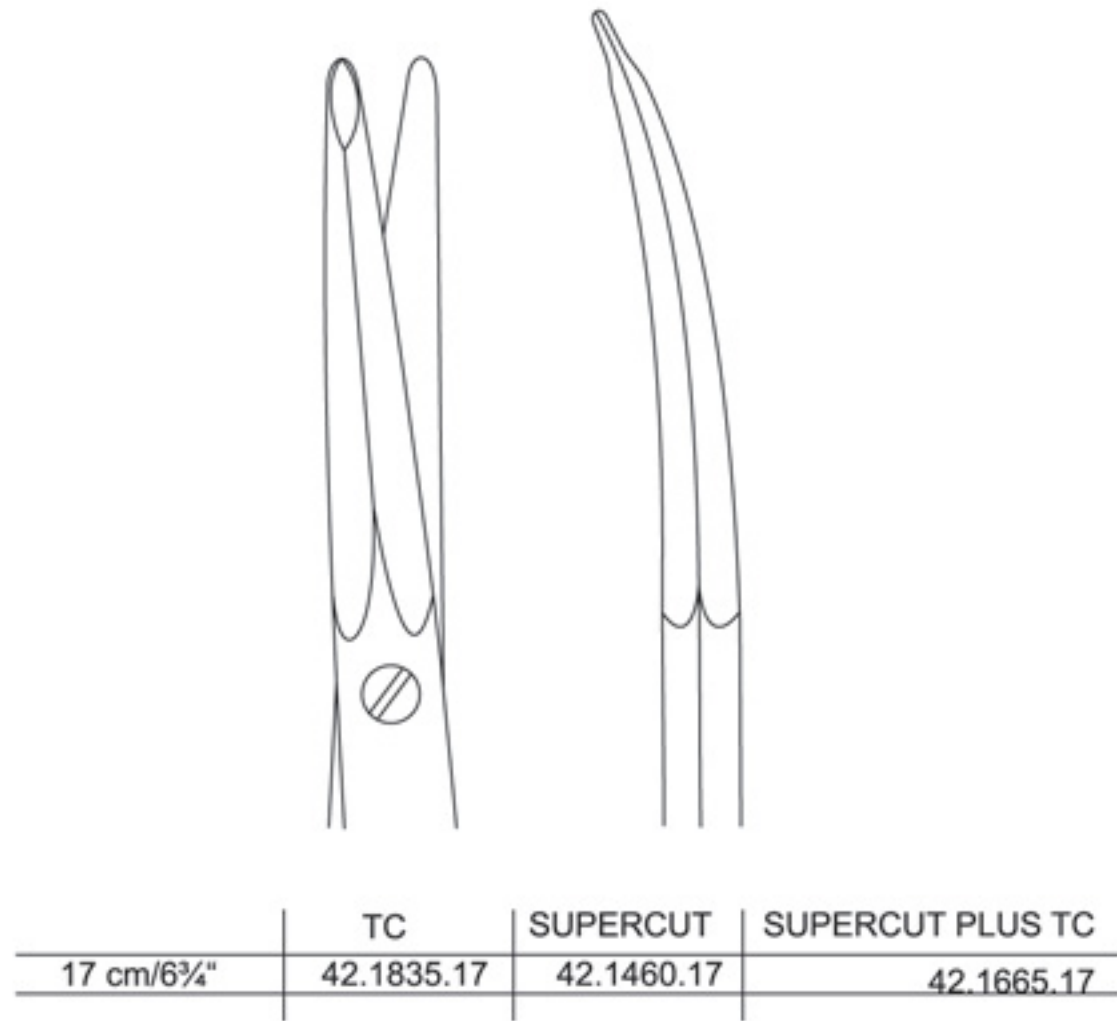

	TC	SUPERCUT	SUPERCUT PLUS TC
17 cm/6¾"	42.1855.17	42.1875.17	42.1680.17



GORNEY-FREEMAN  
FACELIFT



43.0377.10



43.0374.10



(BABY MOSQUITO)  
43.0825.10 - 43.0377.10  
10 cm



43.0497.12



43.0494.12



HALSTEAD MOSQUITO  
43.0494.12 - 43.0497.12  
12.5 cm / 5"



43.0505.12



43.0502.12



KOCHER MOSQUITO  
43.0502.12 - 43.0505.12  
12.5 cm / 5"

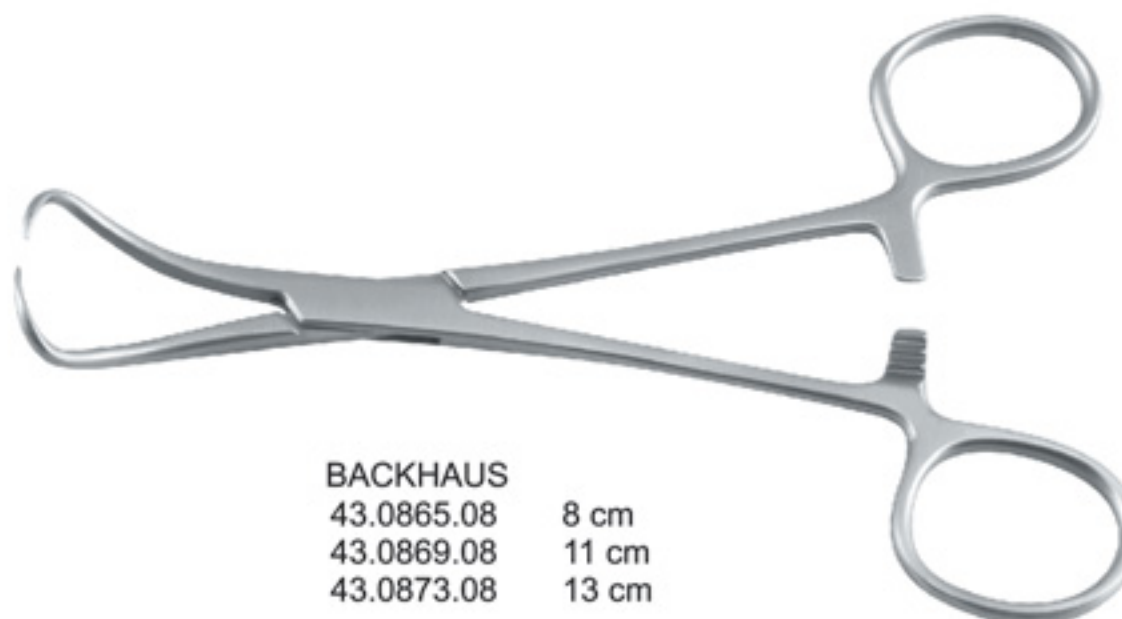

BACKHAUS  
43.0865.08 8 cm  
43.0869.08 11 cm  
43.0873.08 13 cm



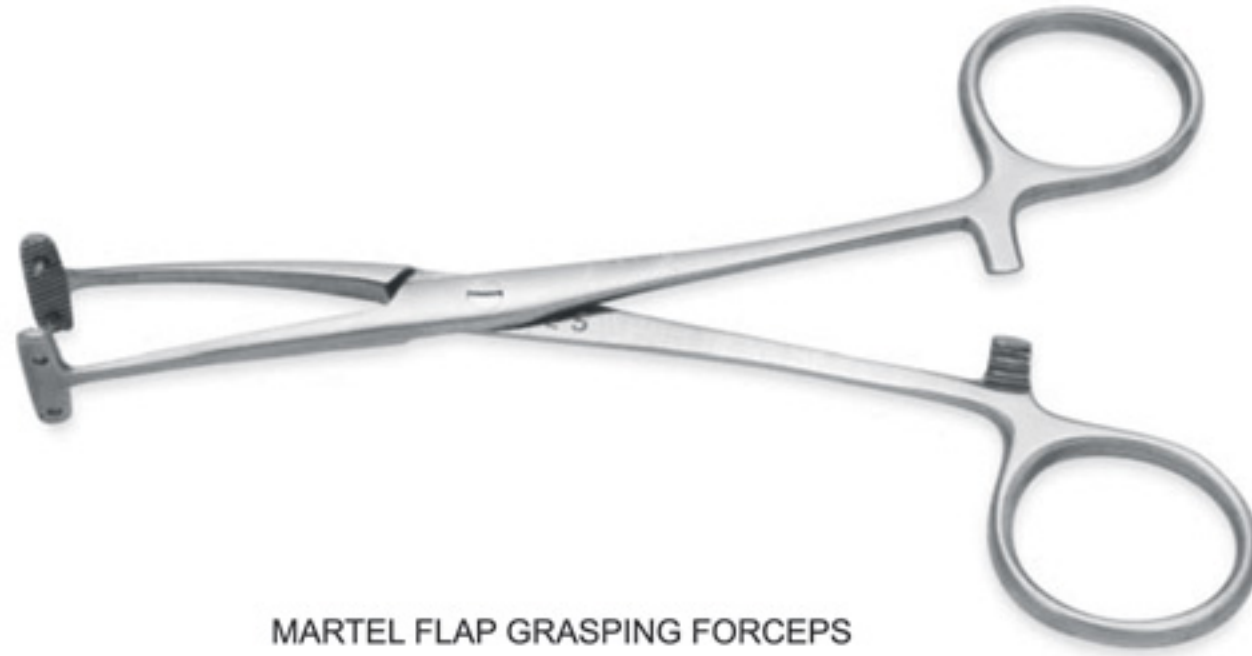

**MARTEL FLAP GRASPING FORCEPS**  
Two pins in opposing holes on the Jaws

47.0301.14  
14cm/5 1/4"



**MARTEN FLAP FORCEPS**  
For accurate marking of skin flaps

47.0303.14  
14cm/5 1/4"



**PITANGUY FORCEPS**

Flap demarcator for accurate marking  
of facial flaps for excision

47.0305.15 15cm/6"  
47.0307.26 26cm/10 1/4"



**ASSUMPCAO FACE LIFT FORCEPS**

For precise marking of dissected  
facial flaps for excision

47.0309.16  
16cm/6 1/4"



Smooth



HALSEY  
46.0288.13  
13 cm



Smooth



HALSEY T/C  
46.0372.13  
13 cm

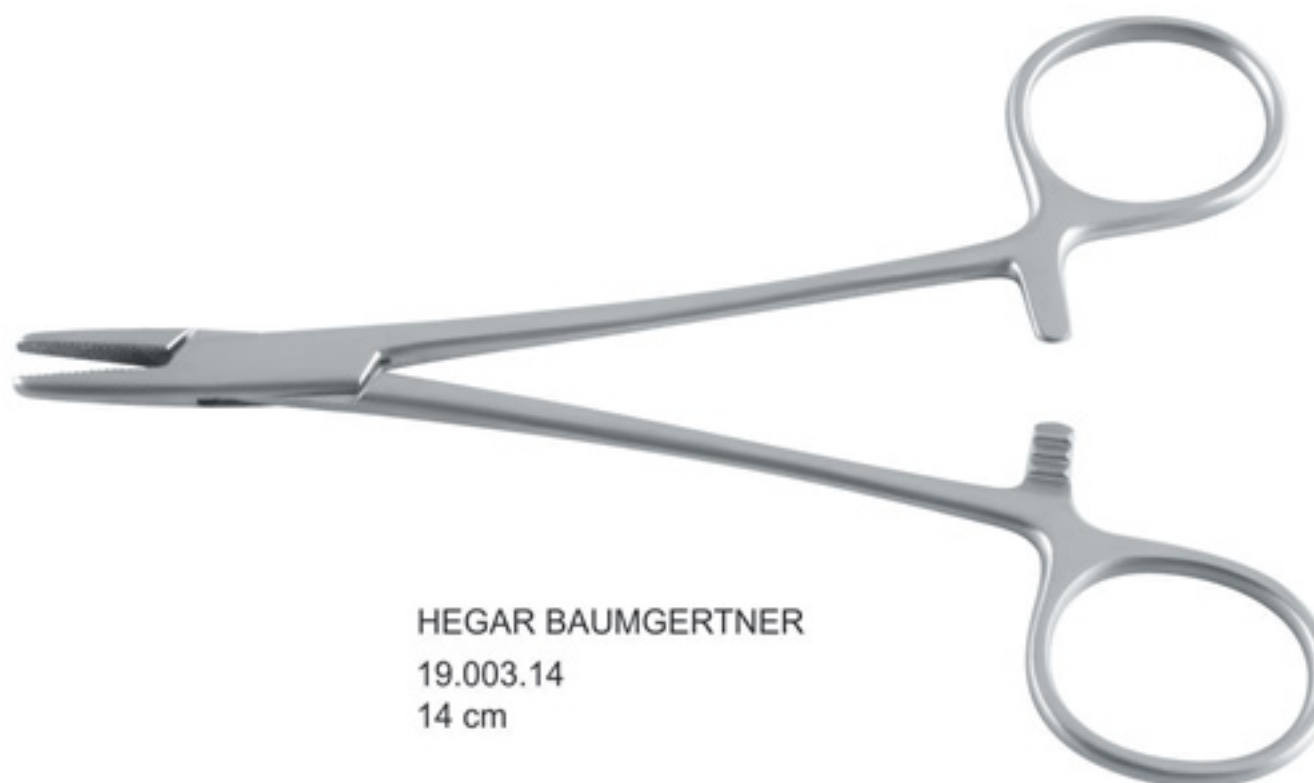

HEGAR BAUMGERTNER  
19.003.14  
14 cm



DERF  
46.0248.12  
12 cm





DERF TC  
46.0368.12  
12 cm



Smooth



WEBSTER, T/C  
46.0380.13  
12.5 cm



KILNER  
46.0280.13  
13.5 cm



KILNER, T/C  
46.0364.13  
13.5 cm



46.0228.18  
18 cm



46.0224.16  
16 cm



MAYO-HEGAR  
46.0224.16 - 46.0228.18



46.0584.18  
18 cm



46.0580.16  
16 cm



MAYO-HEGAR T/C  
46.0580.16 - 46.584.18



CRILE WOOD, T/C  
46.602.15  
15 cm





**BARRAQUER**  
45.0649.05 5mm  
45.0653.07 7mm  
45.0657.10 10mm

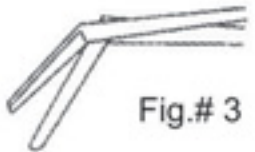

Fig.# 3

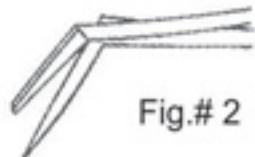

Fig.# 2

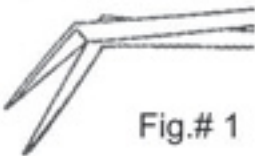

Fig.# 1



**WECKER**  
45.0637.11 Fig.# 1  
45.0641.11 Fig.# 2  
45.0645.11 Fig.# 3  
11 cm



**WESTCOTT**  
45.0457.12  
12 cm

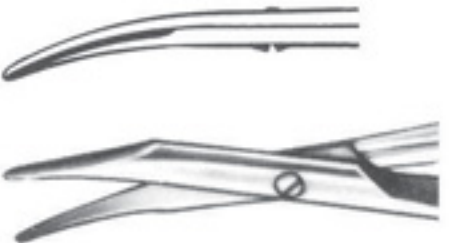

**WESTCOTT**  
45.1894.11  
11 cm,CVD



45.0.769.08



**VANNAS**  
45.0748.08  
8.0 cm



45.0751.08



45.0748.08



**KATZIN**  
45.1926.10  
10 cm

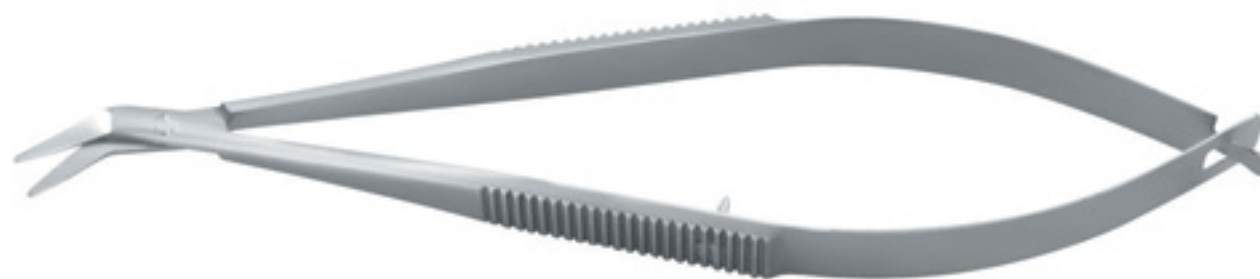

**KATZIN**  
45.1930.10  
10 cm



WEATCOTT  
45.1906.11  
11 cm

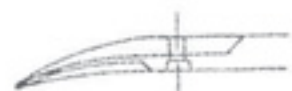

45.0699.18

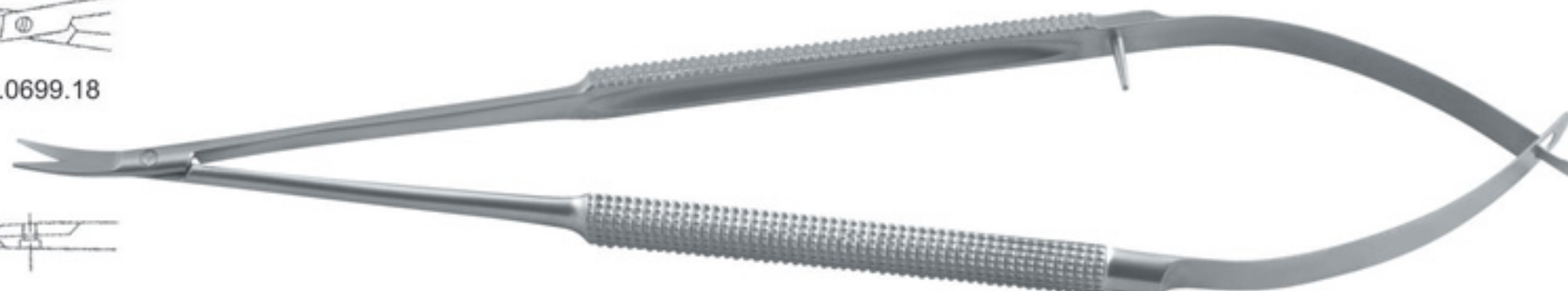

45.0696.18

45.0696.18 - 45.0699.18  
18 cm



45.0475.19

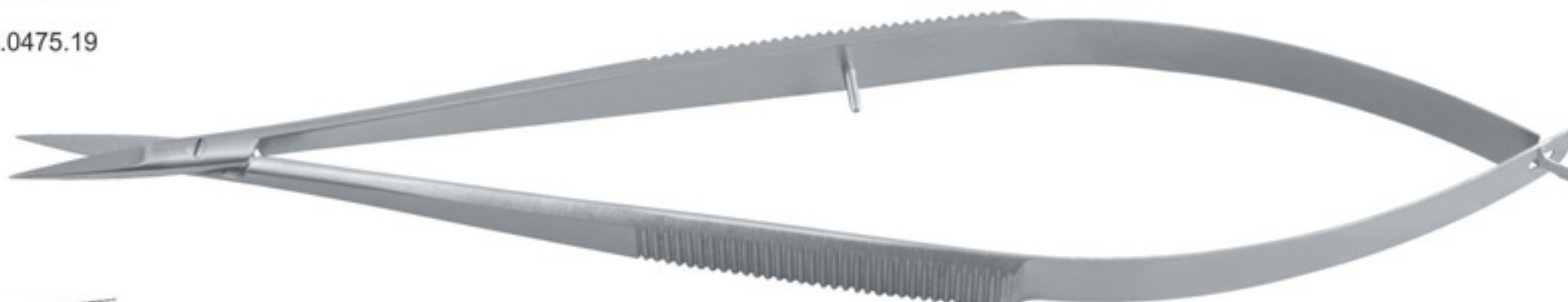

45.0472.19

45.0472.19 - 45.0475.19  
19 cm

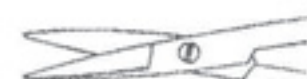

45.0686.15



45.0687.15

MICRO SCISSOR  
45.0686.15 - 45.0687.15  
15 cm



45.0610.12

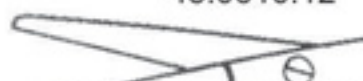
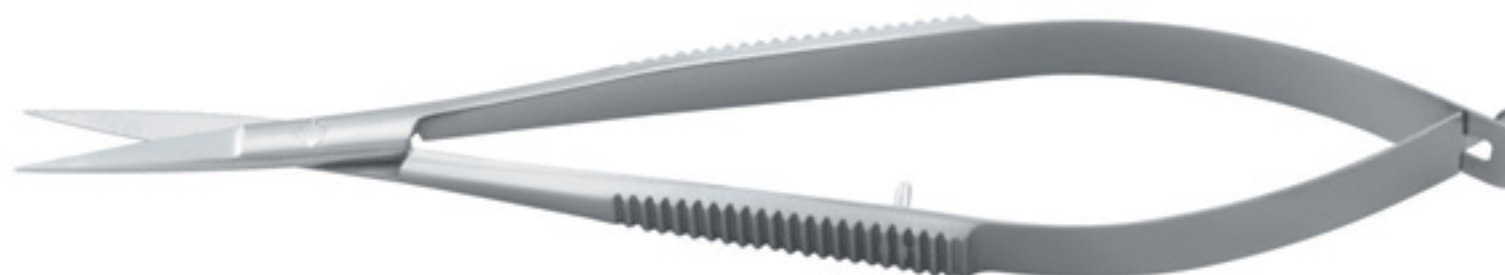

45.0606.12

NOYES  
45.0602.12 - 45.610.12  
12 cm



45.0602.12

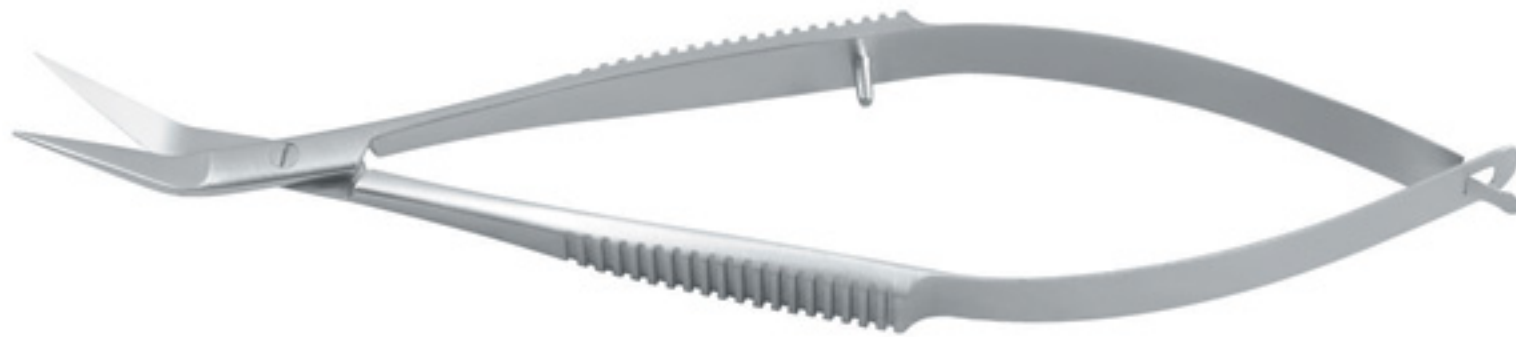

NOYES  
45.0625.12  
12 cm



KATZIN-BARRAQUER  
45.0681.10  
10 cm



KATZIN-BARRAQUER  
45.0677.10  
10 cm



45.1919.10  
10 cm

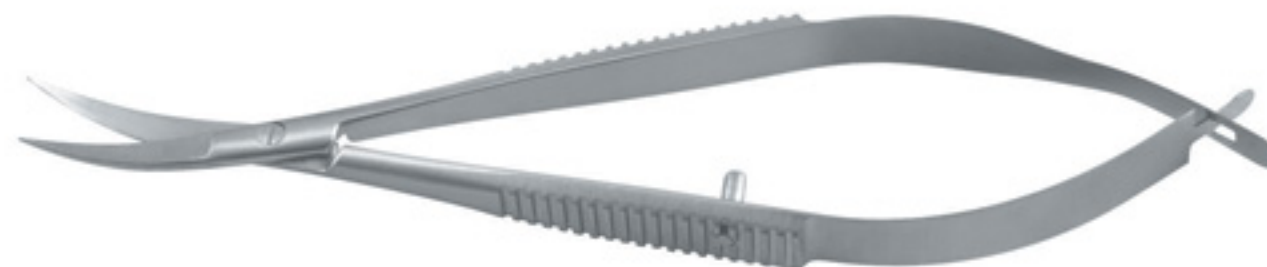

CATROVIEJO  
45.0793.10  
10 cm



45.1902.10  
10 cm





TROUTMAN  
45.1922.10  
10 cm



TROUTMAN  
45.1914.10  
10 cm

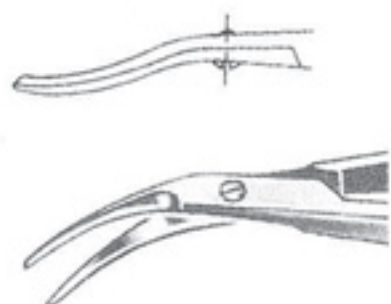

CASTROVIEJO  
45.0809.11  
11 cm



CASTROVIEJO  
45.1910.00



45.1918.15  
15 cm



45.0491.16



45.0491.16



45.0478.16 - 45.491.16  
16 cm



46.0811.09  
46.0811.09



46.0808.09  
46.0808.09



CASTROVIEJO  
46.0808.09 - 46.0811.09  
9 cm

46.1808.09 - 46.1811.09 ( Titanium )  
9 cm



19.0141.14  
46.1451.09



19.0140.14  
46.1450.09

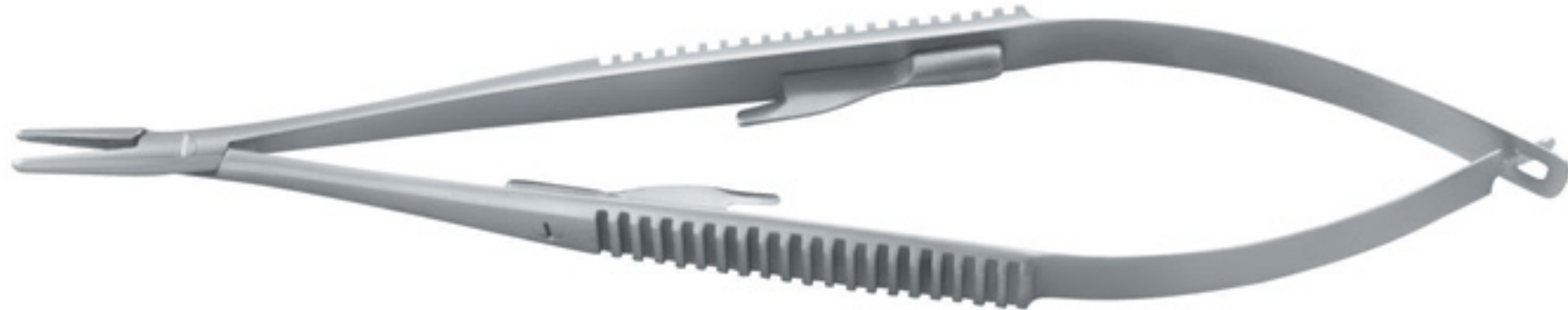

CASTROVIEJO  
19.0140.14 - 19.0141.14  
14 cm

19.1450.14 - 19.1451.14 ( Titanium )  
14 cm



46.0831.14  
46.1831.14



46.0828.14  
46.1828.14

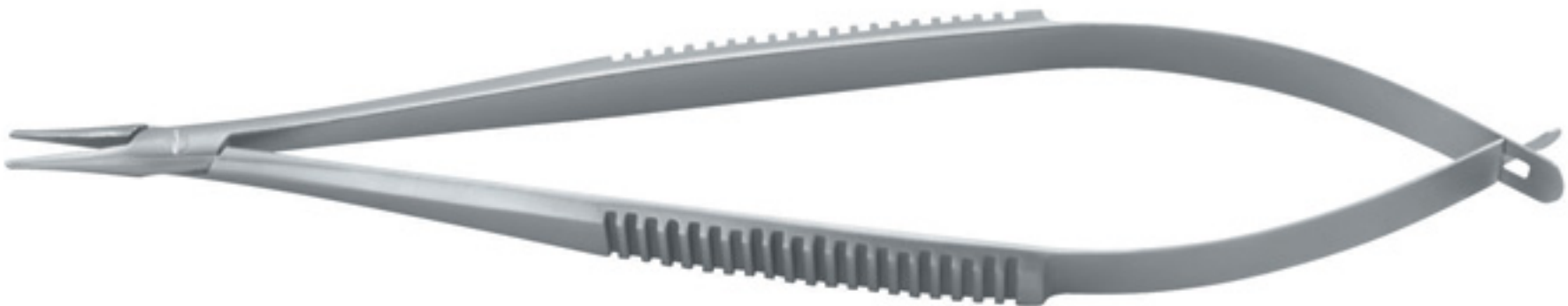

CASTROVIEJO  
46.0828.14 - 46.0831.14  
14 cm

46.1828.14 - 46.1831.14 ( Titanium )  
14 cm



46.0825.14  
46.1825.14



46.0822.14  
46.1822.14

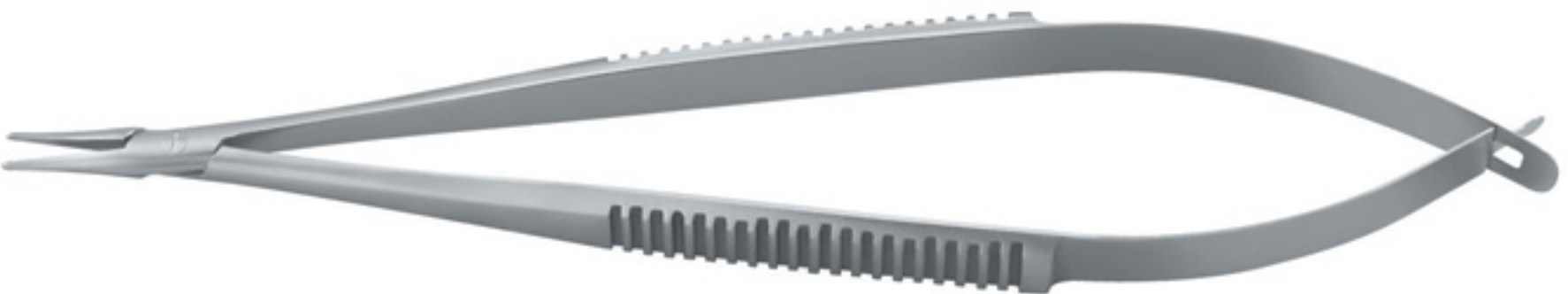

CASTROVIEJO  
46.0822.14 - 46.0825.14  
14 cm

46.1822.14 - 46.1825.14 ( Titanium )  
14 cm



CASTROVIEJO  
45.1712.14  
14 cm  
46.1713.14 ( Titanium)  
14 cm



46.0669.14

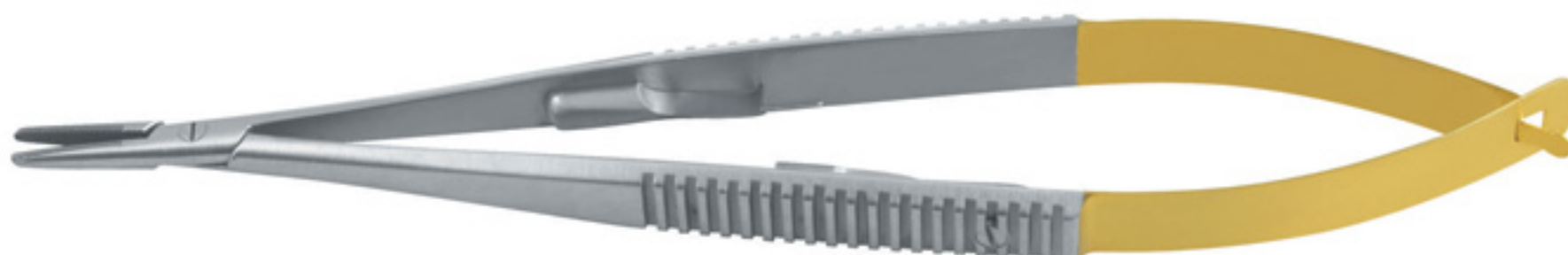

46.0664.14

CASTROVIEJO  
46.0664.14 - 46.0669.14  
14 cm



46.0971.13



46.0968.13

CASTROVIEJO  
46.0968.13 - 46.0971.13  
13 cm

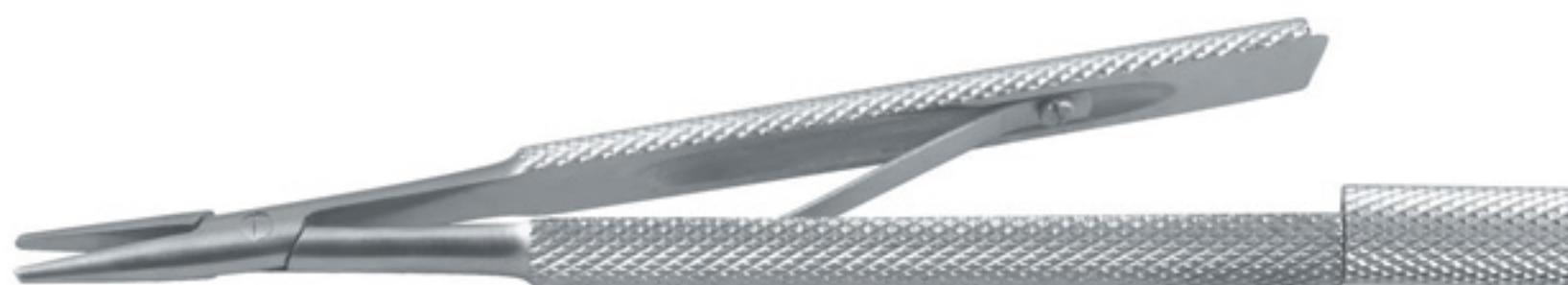

CASTROVIEJO  
45.1724.08 9 cm  
45.1728.13 13 cm



46.0887.14

46.1887.14



46.0884.14

46.1884.14

BARRAQUER  
46.0884.14 - 46.0887.14  
14 cm  
46.1884.14 - 46.1887.14 ( Titanium)  
14 cm



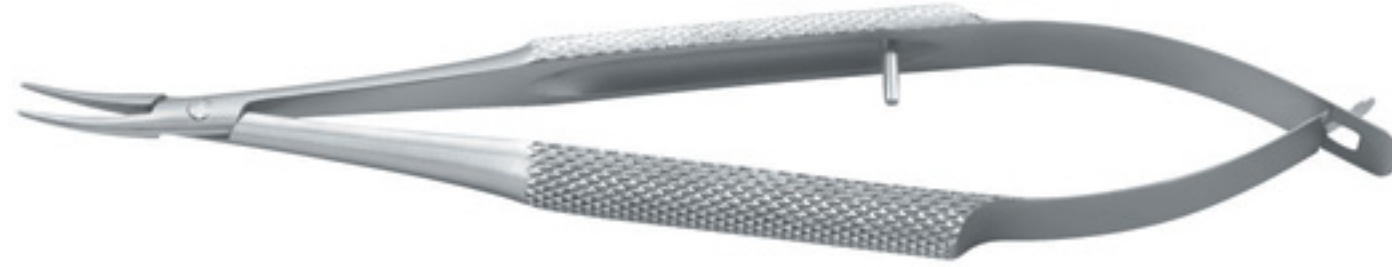

BARRAQUER  
46.0871.11  
11 cm  
46.1871.14 ( Titanium)  
11 cm



BARRAQUER  
46.1708.14  
14 cm  
46.1709.14 ( Titanium)  
14 cm

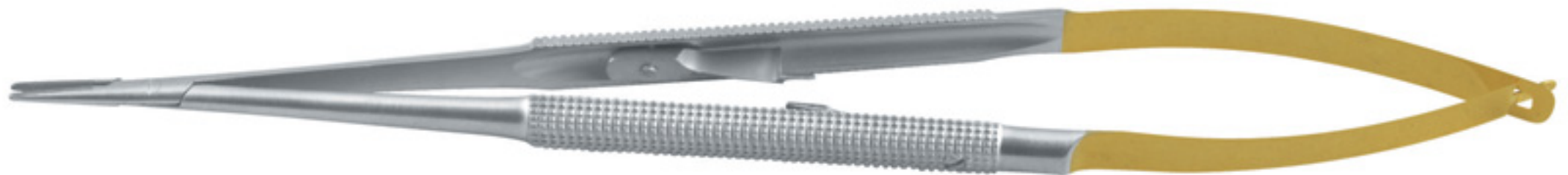

BARRAQUER  
45.1716.18  
18 cm



46.0791.14



46.0786.14



ARRUGA  
46.0786.14 - 46.0791.14  
14 cm



BARRAQUER  
45.1720.11  
11 cm



KALT  
46.0796.14  
14 cm



44.0436.13  
13 cm



1x2 Teeth



44.0444.13  
13 cm



MICRO ADSON  
44.130.12  
12 cm



1x2 Teeth



MICRO ADSON  
44.138.12  
12 cm



ADSON BROWN  
44.1141.12  
12 cm



Straight



SEMKEN  
44.1145.12  
12 cm



Curved



SEMKEN  
44.1146.12  
12 cm



POTTS-SMITH  
44.916.18  
18 cm



POTTS-SMITH  
44.0948.18  
18 cm



DEBAKEY "AT"  
44.0000.15  
15 cm

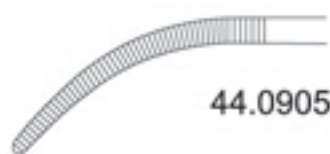

44.0905.17



CUSHING  
44.0902.17 - 44.0905.17  
17 cm



44.0902.17



LUCAE  
44.1100.14  
14 cm



GRUENWALD  
(JANSEN)  
44.1105.16  
16 cm



JWELLER'S STYLE (WATCHMAKER)  
45.0410.12  
12 cm



JWELLER'S STYLE (WATCHMAKER)  
45.1824.12  
12 cm

1.5 mm jaw





GILLIES SHIN HOOK  
48.0558.01  
18 cm



KLIENERT KUTZ  
48.0574.01  
16 cm



JOSEPH DOUBLE SHIN HOOK  
48.0628.16  
16 cm



ROLLET  
48.0616.13  
13 cm



SENN-MILLER  
48.0273.16  
16 cm blunt



SENN-MILLER  
48.0272.16  
16 cm sharp



RAGNELL-DAVIS  
48.0280.14  
14 cm



DESMARRES SADDLE  
48.1610.14  
16 cm , 12 mm width



MARTINEZ KILNR  
48.1615.18  
11.5 cm, 10 mm wide sharp



KILNR ALAE RETRACTOR  
48.1620.08  
8.5 cm 10mm sharp prong



FORMAN ALAE RETRACTOR  
48.1623.16  
16 cm



COTTLE HOOK  
48.1625.16  
14 cm, 1 prong blunt ball & sharp tip



COTTLE HOOK  
48.1702.14  
14 cm, 1 prong blunt ball & sharp tip



FREEMAN FACE LIFT RETRACTOR  
48.1704.00  
1-1/2" Offset Prongs,



FREEMAN FACE LIFT RETRACTOR  
48.1706.10  
10.2 cm



FREEMAN FACE LIFT RETRACTOR  
48.1708.17  
17.8 cm



ALM  
48.0284.07  
7 cm 4x4 teeth



WEITLANER  
48.1244.10 10.5 cm  
18.1245.13 13.5 cm

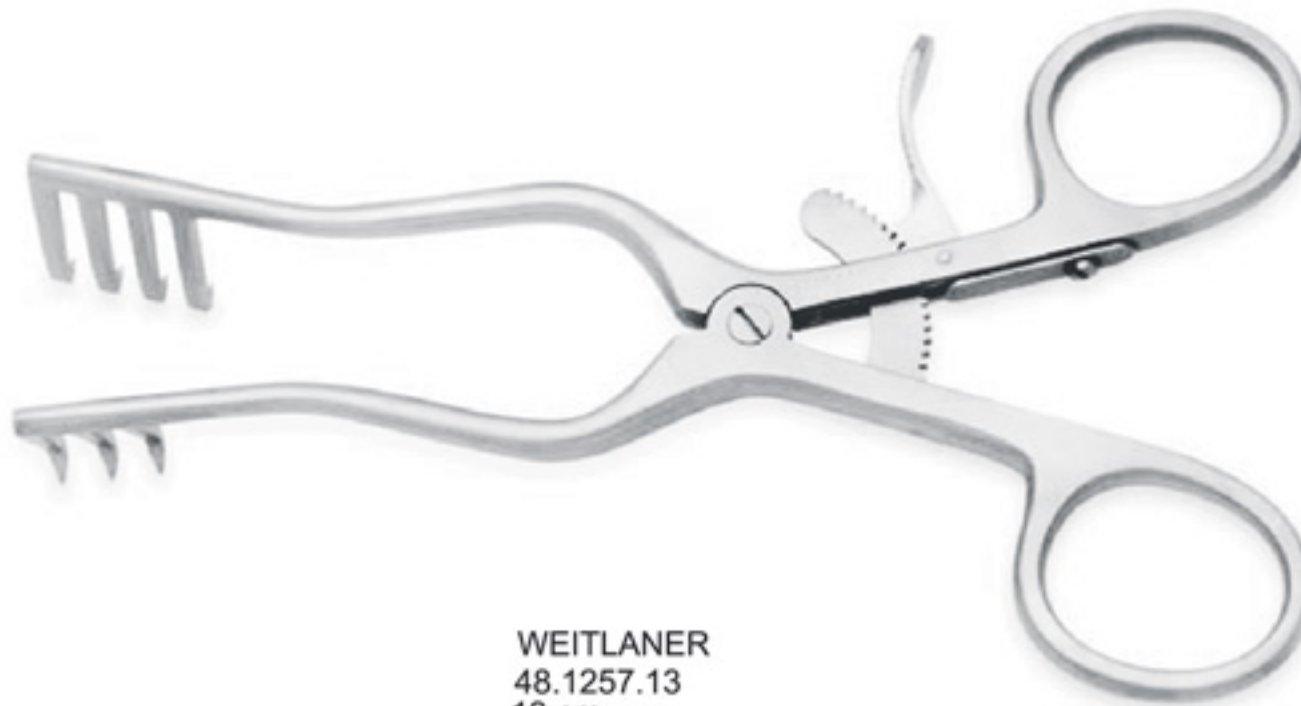

WEITLANER  
48.1257.13  
13 cm



OBWEGESR  
48.1698.15  
15 cm



DESCOLADOR  
48.1630.20  
20 cm





SHEEN NASAL RETRACTOR ANGLED  
48.1710.16  
6-1/2" (165mm) length, 10mm Wide



MALINIAC NASAL RETRACTOR  
48.1712.10  
4" (102mm) length, 45x9mm Blade



PADGETT-DEAVER RETRACTOR  
48.1714.30  
12" (305mm) length, 1" (25mm) Wide



BARSKY NASAL RETRACTOR  
48.1716.09  
3-3/4" (95mm) length, 10x55mm



LAVASSIER  
48.1635.00



BAUER DIREITO  
48.1638.01 Right  
48.1640.02 Left



SAGITAL DIREITO  
48.1642.01 Right  
48.1645.02 Left



OBWEGESER  
48.1650.00 11 x 65 mm  
48.1653.00 11 x 80 mm



OBWEGESER  
48.1658.00 11 x 42 mm  
48.1671.00 11 x 62 mm



OBWEGESER  
48.1673.00 11 x 42 mm  
48.1676.00 11 x 62 mm



MINNESOTA / ASPIRADOR  
48.1679.14  
14 cm



OBWEGESER  
48.1682.17  
17 cm



OBWEGESER  
48.1685.18  
18 cm



WIEDER  
48.1688.00



BAUER DIREITO  
48.1692.24 Right  
48.1695.24 Left  
24 cm





Freeman Flap Retractor Fiber Optic,  
48.1718.00



Freeman Flap Retractor Fiber Optic,  
48.1720.20  
8" (203mm) length, 1/2" (13mm) Wide



Ferreira Face Lift Retractor Fiber Optic  
48.1722.10  
4-1/4" (108mm) length, 22mm Wide Blade



Without Fiberoptic  
48.1724.30 30mm



With Fiberoptic  
48.1726.30 30mm



With Fiberoptic  
48.1728.30 30mm



**BIGGS**



**BIGGS FACE LIFT RETRACTOR**  
48.1730.30  
9" (229mm) length, 5.2cm Wide

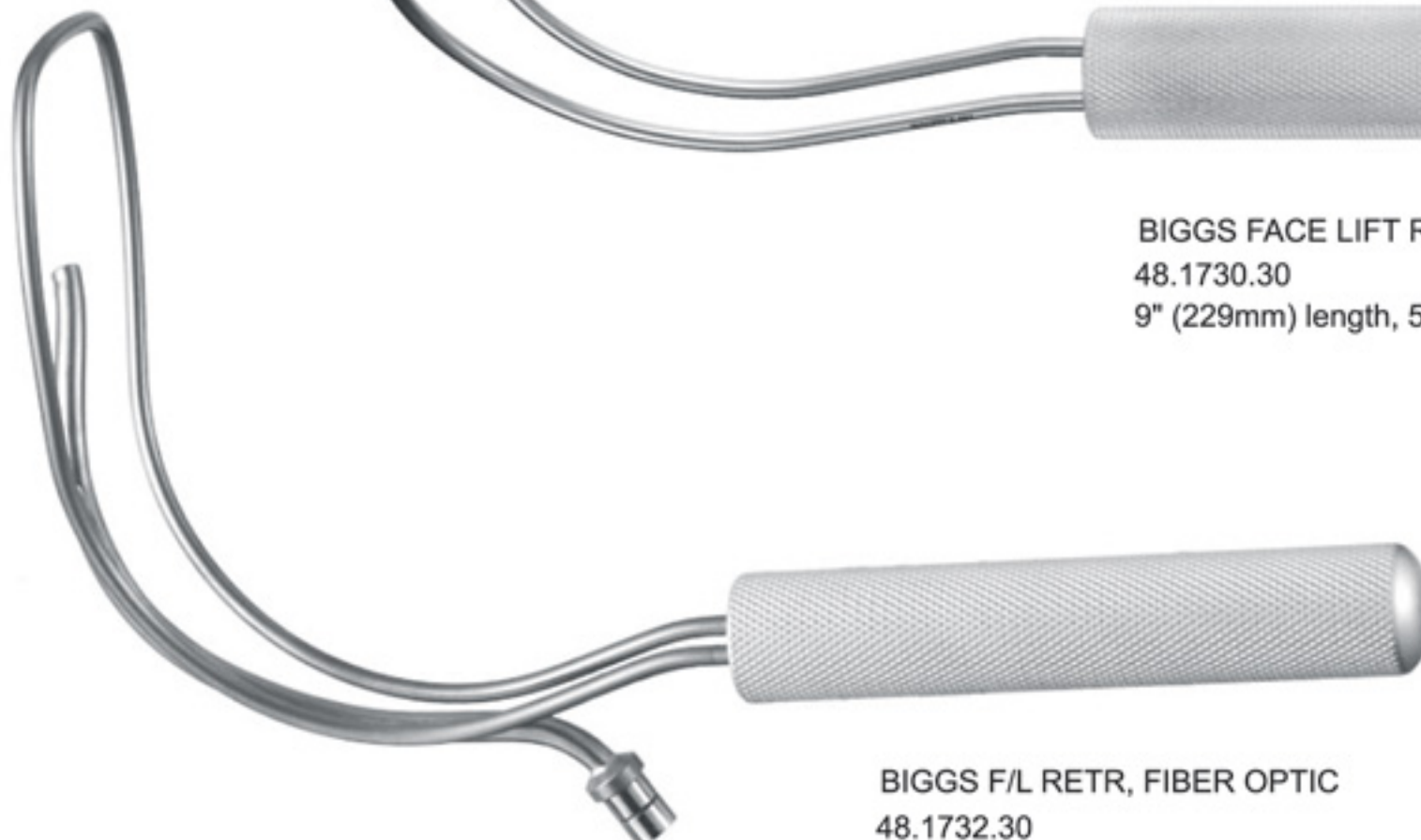

**BIGGS F/L RETR, FIBER OPTIC**  
48.1732.30  
9" (229mm) length, 5.5cm Wide

Tebbetts Fibre Optic Breast Retractor  
With fibre optic illumination and suction

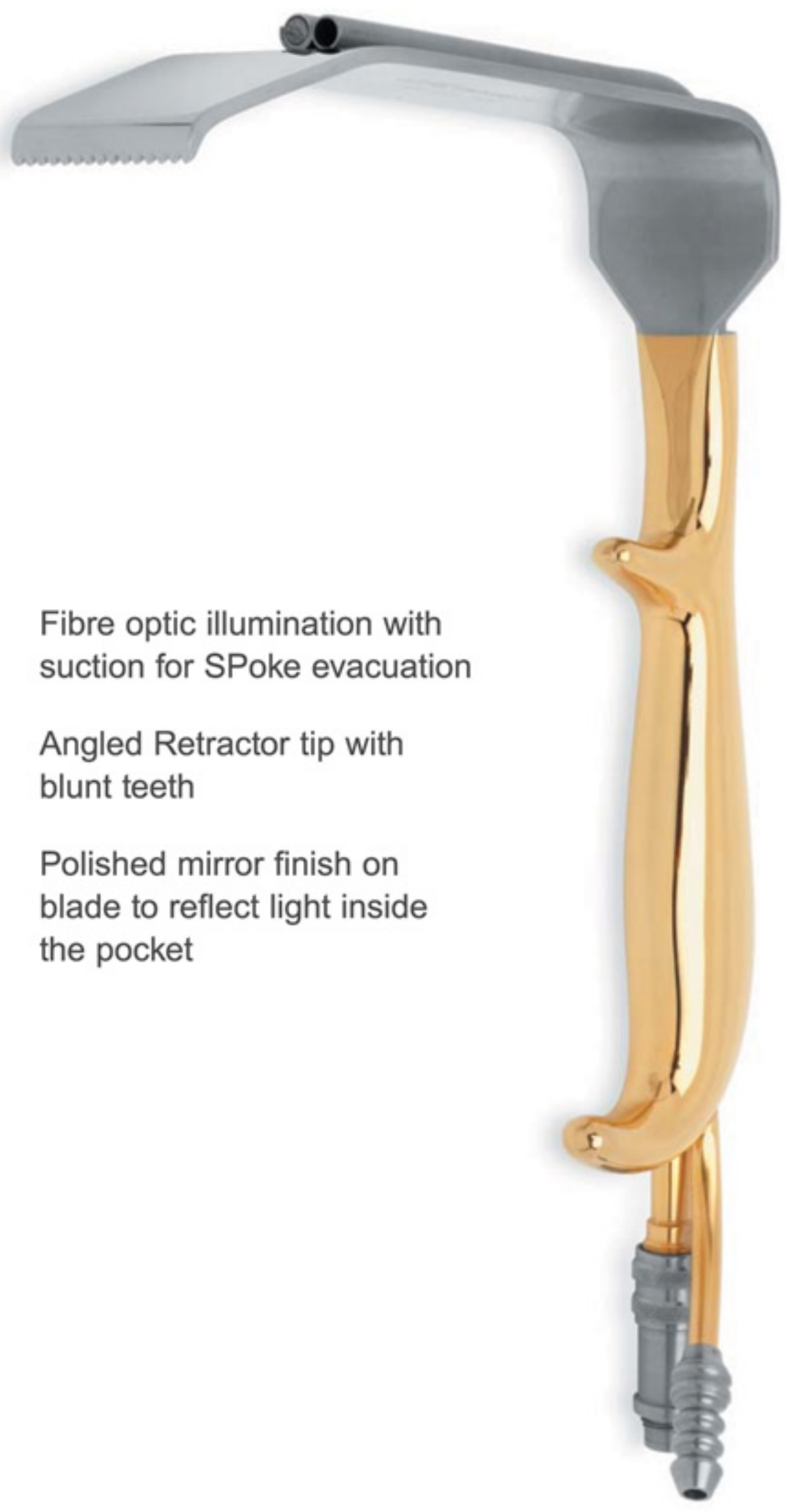
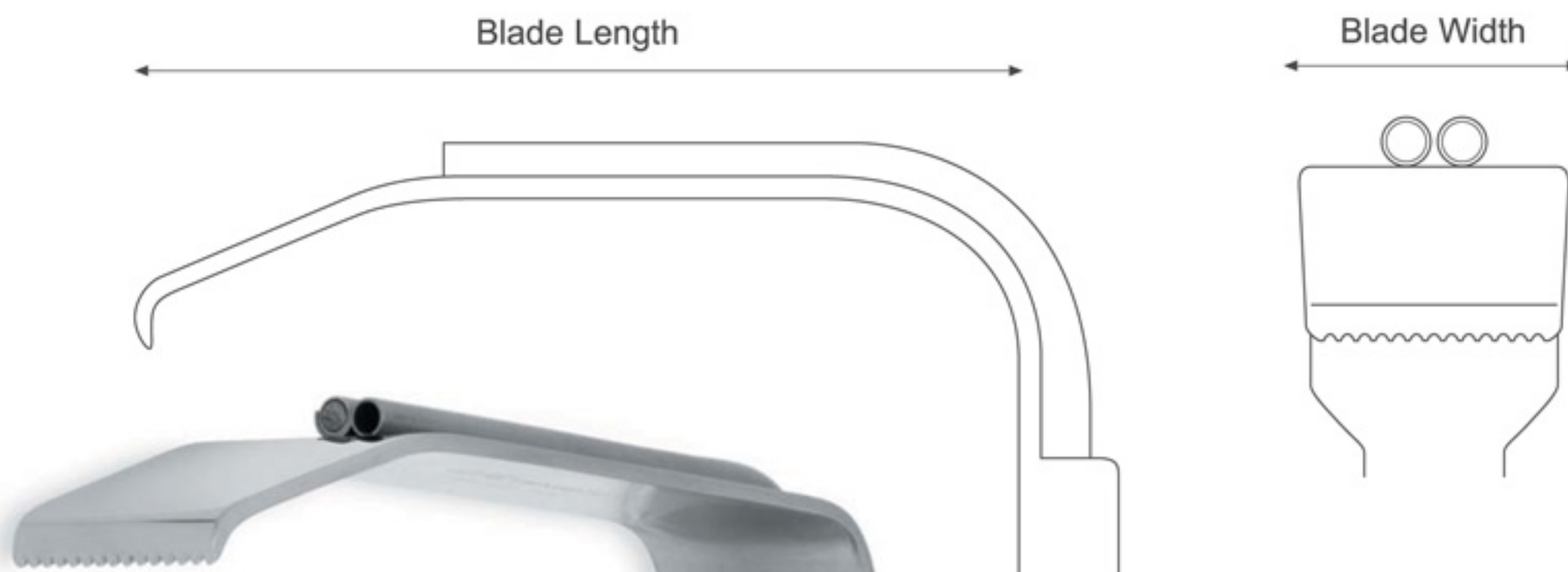

Fibre optic illumination with suction for SPOke evacuation

Angled Retractor tip with blunt teeth

Polished mirror finish on blade to reflect light inside the pocket

Item #	Length	Width
50.1675.18	90mm	24mm
50.1677.18	90mm	30mm
50.1679.18	150mm	36mm
50.1680.18	190mm	36mm





BREAST RETRACTOR  
Fiber optic & Adapter  
48.1708.00 70 x 16 mm  
48.1712.00 90 x 27 mm



BREAST RETRACTOR  
Fiber optic & Adapter  
48.1716.00 130 x 16 mm  
48.1720.00 150 x 25 mm  
48.1724.00 180 x 16 mm  
48.1728.00 150 x 16 mm  
48.1732.00 180 x 25 mm  
48.1736.00 220 x 27 mm



BREAST RETRACTOR  
Suction  
48.1740.00 80 x 16 mm  
48.1744.00 90 x 27 mm  
48.1744.00 150 x 25 mm



BREAST RETRACTOR  
Suction Size Angle  
48.1750.00 180 x 16 mm 120°  
48.1756.00 180 x 25 mm 120°  
48.1760.00 180 x 27 mm 120°  
48.1776.00 180 x 30 mm 120°



BREAST RETRACTOR		
Suction	Size	Angle
48.1768.00	180 x 16 mm	130°
48.1772.00	180 x 25 mm	130°
48.1777.00	180 x 27 mm	130°
48.1780.00	180 x 30 mm	130°



BREAST RETRACTOR	
Fiber Optic	Size
48.1784.00	270 x 45 x 25 mm



TEBBETS STYLE	
Fiber Optic	Size
48.1788.00	80 x 16 mm
48.1792.00	90 x 30 mm
48.1794.00	90 x 24 mm
48.1798.00	36 x 16 mm
48.1802.00	100 x 25 mm
48.1806.00	120 x 25 mm
48.1810.00	150 x 25 mm
48.1814.00	150 x 30 mm



TEBBETS STYLE	
Fiber Optic	Size
48.1818.00	70 x 14 mm
48.1822.00	80 x 16 mm
48.1826.00	230 x 13 mm
48.1830.00	230 x 25 mm
48.1834.00	100 x 25 mm
48.1838.00	120 x 25 mm
48.1842.00	120 x 30 mm
48.1846.00	150 x 25 mm
48.1850.00	150 x 30 mm



**WIEDER RETRACTOR**  
Suction    Size  
48.1900.00    130 x 30 mm  
48.1904.00    130 x 40 mm



**WIEDER RETRACTOR**  
Suction    Size  
48.1908.00    130 x 30 mm  
48.1912.00    130 x 40 mm



**SPECULAMS**  
Fiber Optic    Size  
48.2260.00    35 x 130 mm  
48.2264.00    50 x 130 mm  
48.2268.00    75 x 130 mm  
48.2272.00    90 x 130 mm



**SPECULAMS**  
Fiber Optic    Angle  
48.2500.00    75° 8FR  
48.2504.00    75° 10FR  
48.2508.00    30° 8FR  
48.2512.00    30° 10FR





FREEMAN AREOLA MARKER

50.1750.00 36mm Ø  
 50.1751.00 38mm Ø  
 50.1752.00 40mm Ø  
 50.1753.00 42mm Ø  
 50.1754.00 50 mm Ø

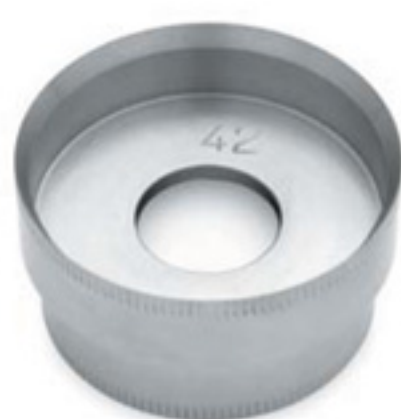

FREEMAN DOUBLE ENDED AREOLA MARKER

50.1760.00 38/42mm Ø  
 50.1762.00 42/45mm Ø



GALVAO NIPPLE MARKER

50.1765.00 40mm Ø standard  
 50.1766.00 50mm Ø large

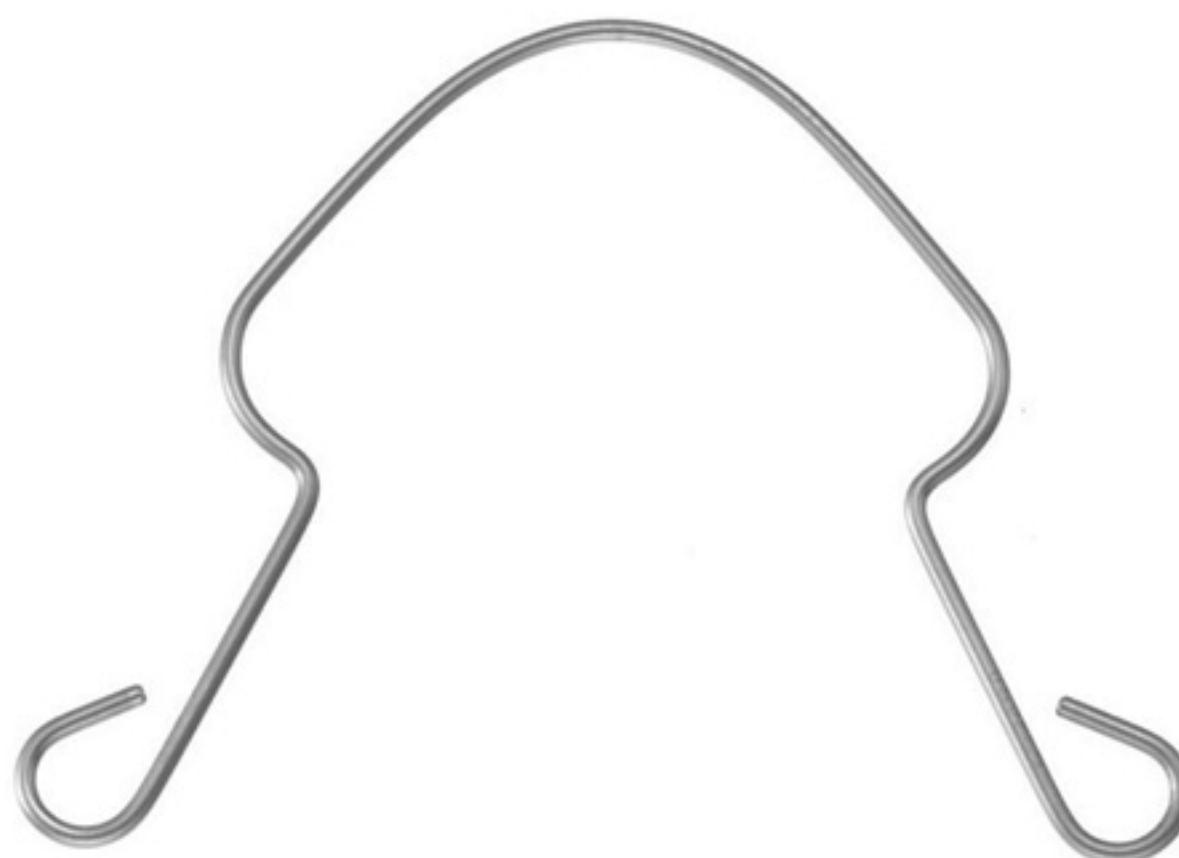

ACKERMAN AREOLA MARKER

50.1768.14  
 140mm Dia



MCKISSOCK KEYHOLE BREAST REDUCTION MARKER

50.1770.00 38mm Ø  
 50.1772.00 42mm Ø  
 50.1774.00 45mm Ø

- Ø Precisely marks amount of Tissue for removal
- Ø Used together with Freeman Marker
- Ø Arms are graduated in centimeters for marking tissue to be removed



AUFRICHT NASAL  
50.1628.16  
16 cm



JOSEPH SAW  
50.1629.19  
19 cm



JOSEPH SAW  
50.1630.00 left  
50.1631.00 right  
125 mm x 85 mm



BALLENGER SWIVEL KNIFE  
50.1632.19  
19 cm

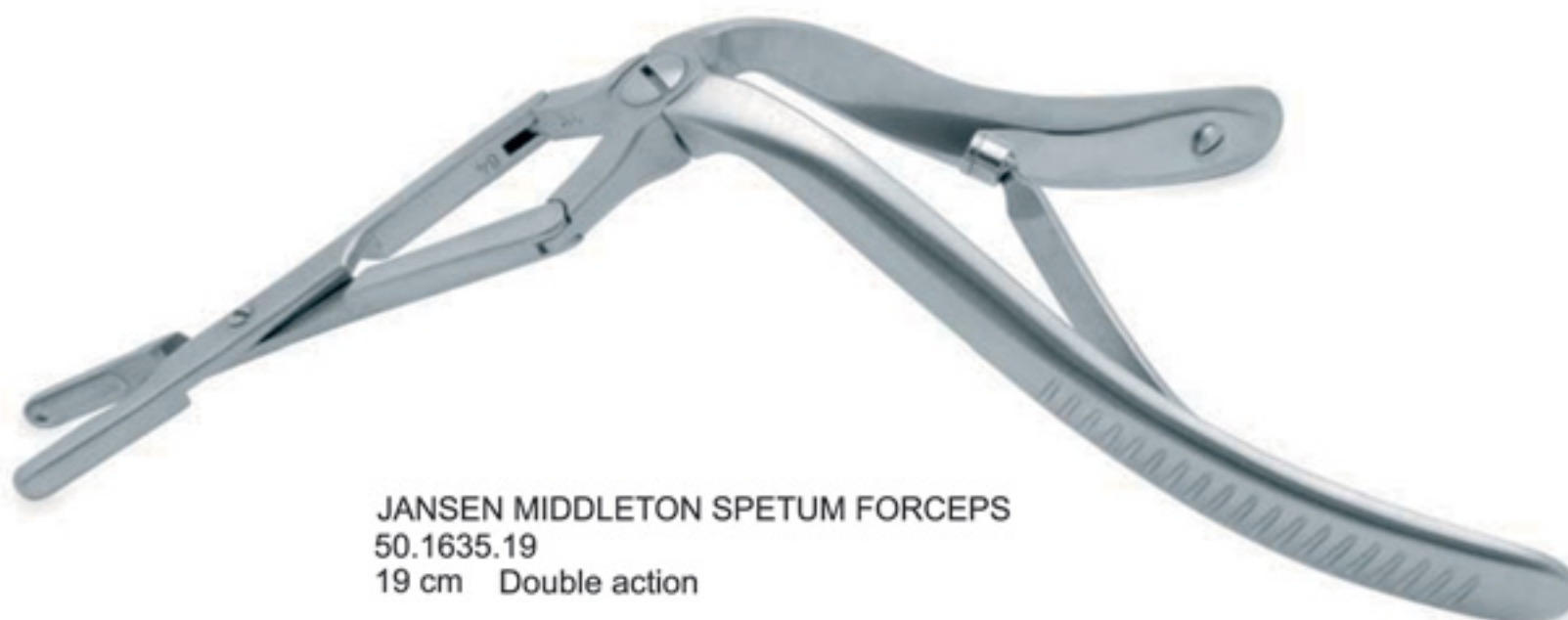

JANSEN MIDDLETON SPETUM FORCEPS  
50.1635.19  
19 cm Double action



FORMAN DOUBLE END NASAL RASP  
21 cm, T/c



50.1640.21



50.1642.21



50.1644.21



PARKES NASAL RASP  
Backward cutting  
21 cm, T/c



50.1646.21



50.1648.21

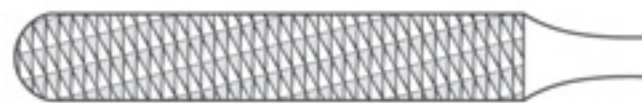

50.1650.21



MALTZ  
50.1652.18  
18.5 cm



MALTZ T/c  
50.1654.18  
18.5 cm





PEET NASAL RASP - CURVED  
Diamond Surface  
50.1776.17  
17.5cm



AUFRICHT (PEET) NASAL RASP  
Diamond Surface  
50.1778.22  
22cm



GLABELLA NASAL RASP  
Tungsten Carbide Surface  
50.1780.21  
21cm



FOMAN DOUBLE ENDED NASAL RASP  
Diamond Surface  
50.1782.21  
21cm



MILLAR NASAL RASP  
Tungsten Carbide Surface  
18cm



50.1784.18



50.1786.18



Cottle Chisel  
18.5cm/7 1/2"  
50.1790.18 4 mm  
50.1791.18 6 mm  
50.1792.18 7 mm  
50.1793.18 8mm  
50.1794.18 9mm  
50.1795.18 12mm



French (Gillies) Osteotome  
14cm/5 1/2"  
50.1796.14 2 mm  
50.1797.14 5 mm  
50.1798.14 7 mm  
50.1799.14 9 mm  
50.1801.14 11 mm  
50.1802.14 13 mm



Rubin Osteotome  
18cm/7"  
50.1803.18 8 mm  
50.1804.18 10 mm  
50.1805.18 12 mm  
50.1806.18 14 mm  
50.1807.18 16 mm



McIndoe Chisel  
15cm/6"  
50.1808.15 9 mm  
50.1809.15 11 mm  
50.1810.15 13 mm  
50.1811.15 15 mm



Foman Chisel with guard  
16.5cm/6 1/2"  
50.1811.16 4 mm  
50.1812.16 5 mm  
50.1813.16 6 mm  
50.1814.16 7 mm



Cinelli Double Guarded Osteotome  
16cm/6 1/4"

- 50.1815.16 8 mm
- 50.1816.16 10 mm
- 50.1817.16 12 mm
- 50.1818.16 14 mm
- 50.1819.16 16 mm



Silver Chisel with guard (Frenchay)  
18cm/7"

- 50.1820.18 Straight
- 50.1821.18 Curved left
- 50.1822.18 Curved right



Nievert Chisel with Guard  
20cm/8"

- 50.1823.20 Straight
- 50.1824.20 Curved left
- 50.1825.20 Curved right



Braithwaite Chisel  
14.5cm/5 3/4", 5mm wide

- 50.1826.14 Without guard
- 50.1827.14 Guard on left
- 50.1828.14 Guard on right



Killian Septum Gouge  
Round cutting edge bayonet shaped 6mm width

- 50.1830.16
- 16cm/6 1/4"



Killian Septum Gouge  
Notched edge bayonet shaped 6mm width

- 50.1832.16
- 16cm/6 1/4"





WAGNER  
57.1501.00 4mm  
50.1503.00 6mm  
50.1507.00 8mm



WAGNER  
57.1511.00 6mm  
50.1515.00 8mm



WAGNER  
57.1519.00 4mm



MEAD  
57.0102.17  
17 cm, ø 26 mm

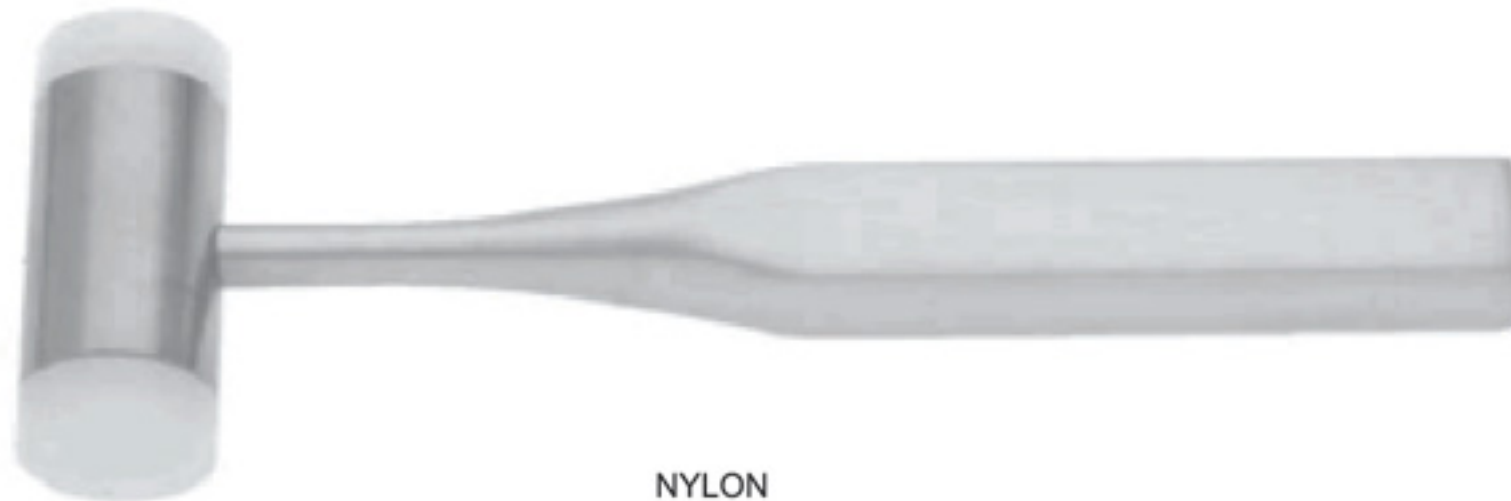

NYLON  
57.1525.00  
18.5 cm



GERZOG  
57.1530.00  
18 cm, 250g



**COTTLE**  
15 cm / 6"

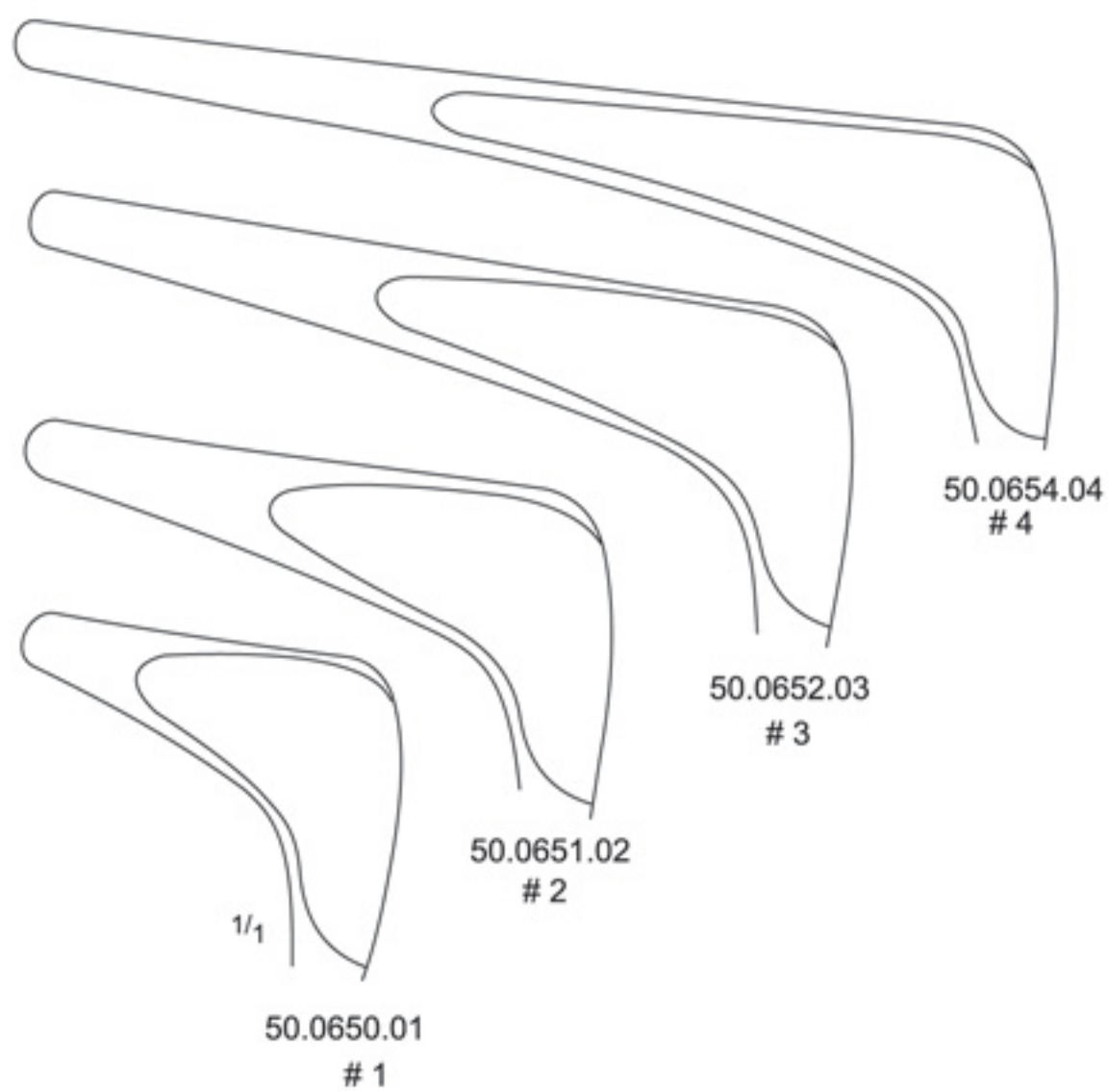

**HARTMANN-HALLE**  
15 cm / 6"

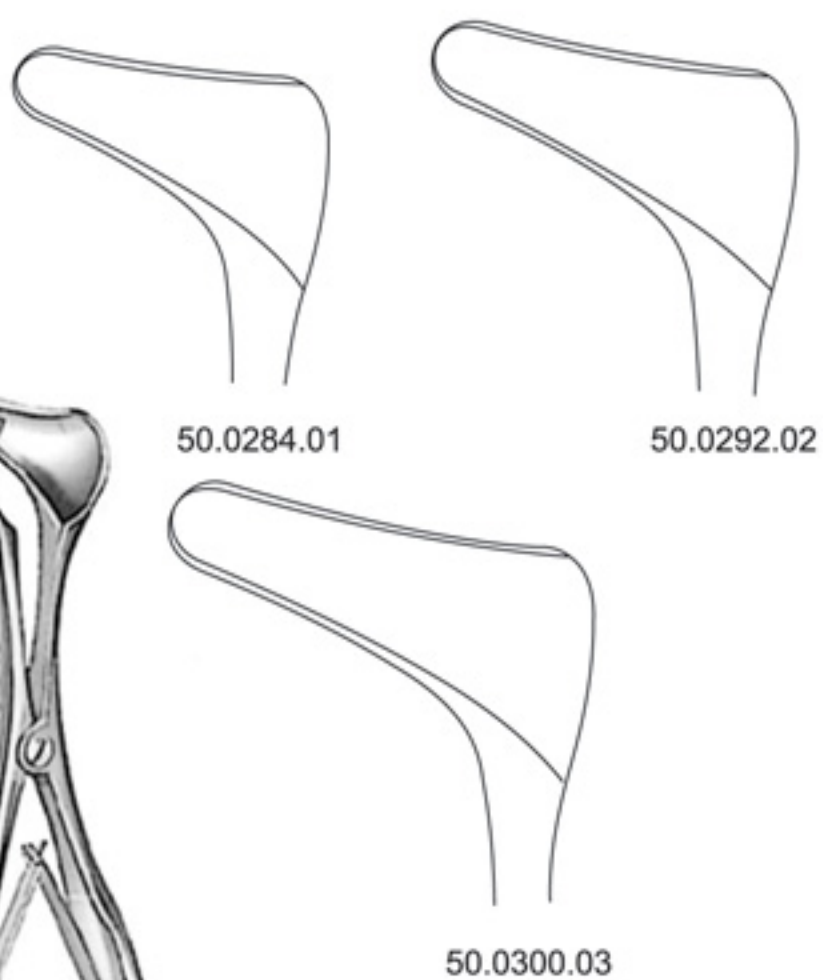



KILLIAN  
14 cm / 5 1/2"

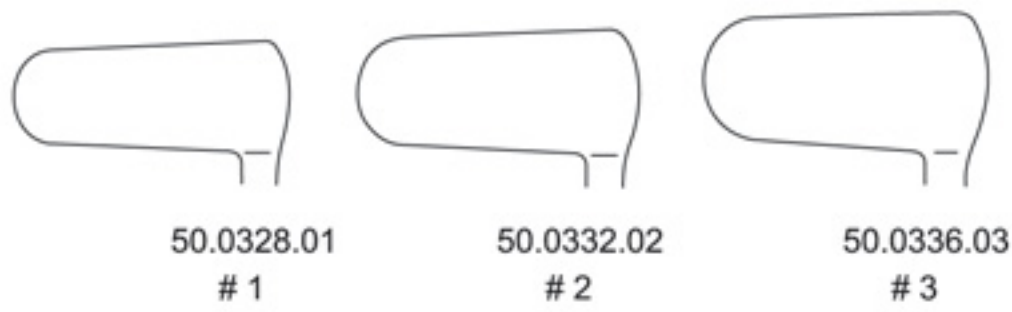
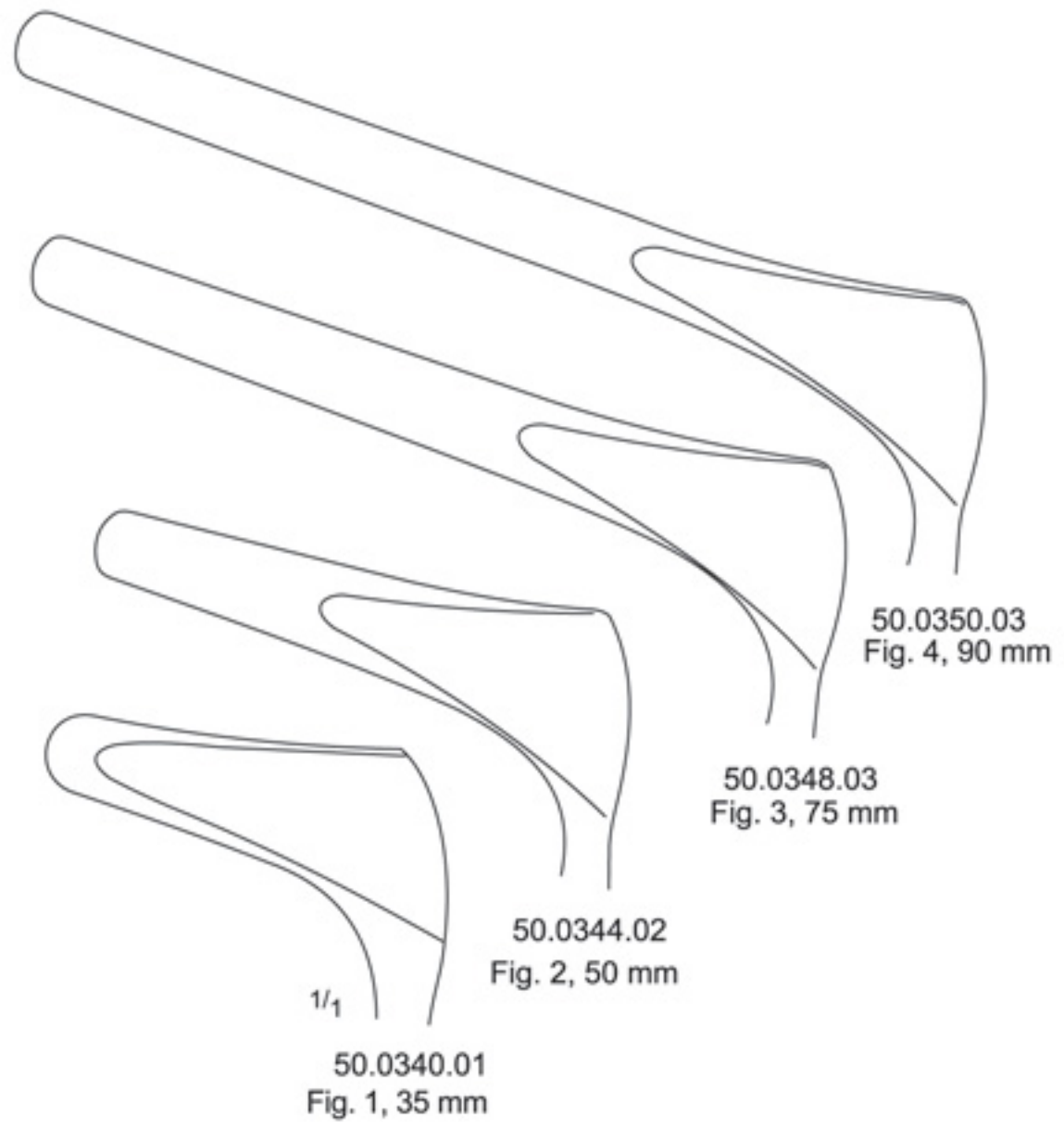

GOLDSMITH (THUDICUM)  
6.5 cm / 2 1/2"





WATSON SKIN GRAFT KNIFE  
41.1350.30  
30 cm



BRAITHWAITE SKIN GRAFT KNIFE  
41.1355.30  
30 cm

One central hole / two lateral holes

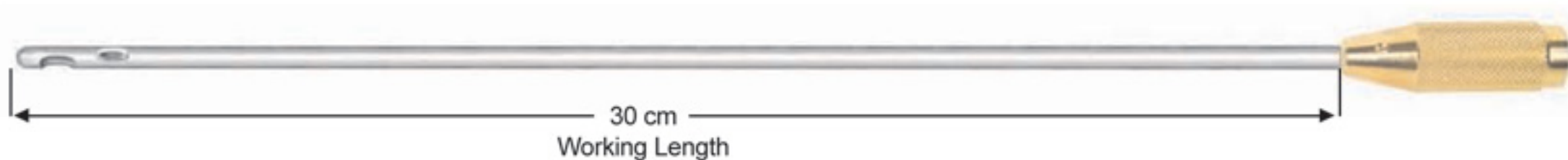

100-101.30  
30 cm  
ø 5mm



100-102.30  
30 cm  
ø 5mm



Three holes, diagonal



100-104.20  
20 cm  
ø 3 mm



100-105.30  
30 cm  
ø 4 mm



100-106.30  
30 cm  
ø 5 mm



100-107.40  
40 cm  
ø 6 mm



For infiltration



100-110.25  
25 cm  
ø 2 mm



100-111.25  
25 cm  
ø 3 mm

Point with hole/one lateral hole

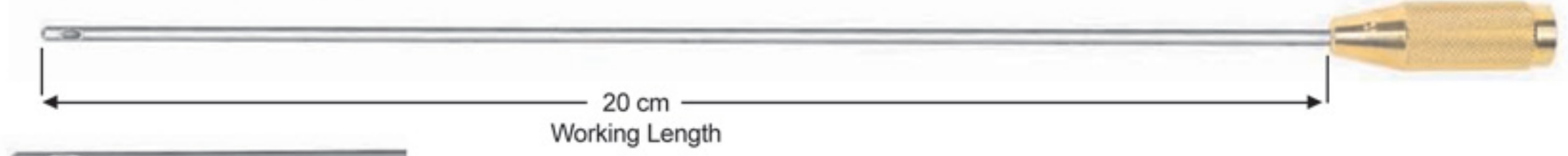

100-115.20  
20 cm  
Ø 3mm

100-116.30  
30 cm  
Ø 3mm



6x10 mm



100-117.30  
30 cm

100-118.35  
35 cm



One lateral hole  
For fine proportioning in facial sections



100-119.05  
5 cm  
Ø 1.7 mm

100-120.06  
15 cm  
Ø 1.7 mm



100-121.05  
5 cm  
Ø 2.0 mm

100-122.06  
15 cm  
Ø 2.0 mm



100-123.05  
5 cm  
Ø 3.0 mm

100-124.06  
15 cm  
Ø 3.0 mm





100-125.05  
5 cm  
ø 1.7 mm

100-126.06  
15 cm  
ø 1.7 mm



100-127.05  
5 cm  
ø 2.0 mm

100-128.06  
15 cm  
ø 2.0 mm



100-129.05  
5 cm  
ø 3.0 mm

100-130.06  
15 cm  
ø 3.0 mm



three lateral holes



100-131.15  
15 cm  
ø 3.0 mm

100-132.25  
25 cm  
ø 3.0 mm



100-133.15  
15 cm  
ø 4.0 mm

100-134.25  
25 cm  
ø 4.0 mm



One central hole, two lateral holes



100-135.20  
20 cm  
ø 3.0 mm



100-136.30  
30 cm  
ø 4.0 mm



100-137.30  
30 cm  
ø 5.0 mm



100-138.30  
30 cm  
ø 6.0 mm

One lateral hole

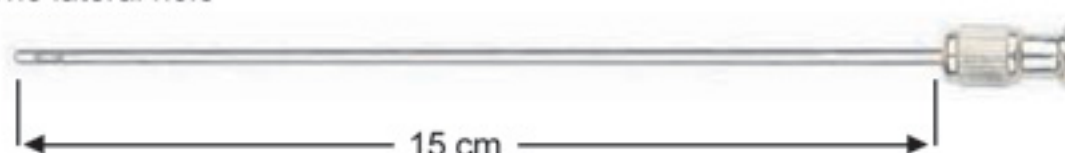

15 cm  
Working Length

with LUER-LOCK connector

**18 Holes**



15 cm  
Working Length

hole  $\varnothing$  1.0 mm



100-139.15  
15 cm  
 $\varnothing$  2.0 mm

hole  $\varnothing$  1.5 mm



100-140.15  
15 cm  
 $\varnothing$  3.0 mm

**18 Holes**



hole  $\varnothing$  1.0 mm



100-141.15  
15 cm  
 $\varnothing$  2.0 mm

hole  $\varnothing$  1.5 mm



100-142.15  
15 cm  
 $\varnothing$  3.0 mm

**22 Holes**



hole  $\varnothing$  1.5 mm



100-143.20  
20 cm  
 $\varnothing$  3.0 mm

hole  $\varnothing$  2.0 mm



100-144.20  
20 cm  
 $\varnothing$  4.0 mm

**22 Holes**



hole  $\varnothing$  1.5 mm



100-145.20  
20 cm  
 $\varnothing$  3.0 mm

hole  $\varnothing$  2.0 mm



100-146.20  
20 cm  
 $\varnothing$  4.0 mm

The bayonet shaped handles allow an easier manipulation.

**22 Holes**



hole  $\varnothing$  1.5 mm

100-147.20  
20 cm  
 $\varnothing$  3.0 mm



hole  $\varnothing$  2.0 mm

100-148.20  
20 cm  
 $\varnothing$  4.0 mm

**22 Holes**



hole  $\varnothing$  1.5 mm

100-149.20  
20 cm  
 $\varnothing$  3.0 mm



hole  $\varnothing$  2.0 mm

100-150.20  
20 cm  
 $\varnothing$  4.0 mm

**8 Holes**



hole  $\varnothing$  1.0 mm

100-151.15  
15 cm  
 $\varnothing$  2.0 mm



**8 Holes**



hole  $\varnothing$  1.0 mm

100-152.15  
15 cm  
 $\varnothing$  2.0 mm



Handle with connection thread for cannulas hose  
connection  $\varnothing$  13mm for operation with a suction pump.



100-153.00

with rotatable tube connection



100-154.00



100-155.00

with rotatable tube connection



100-156.00













## **GLORIOUS ENTERPRISES**

P.O.Box:63, Vaerkstedsgarden 9,  
DK - 2620 Albertslund, DENMARK  
Tel: 0045 43 622693  
Fax: 0045 43 622611  
E-mail: [glorious@mail.dk](mailto:glorious@mail.dk)